

# R.T. LARGE

ESTABLISHED 1969

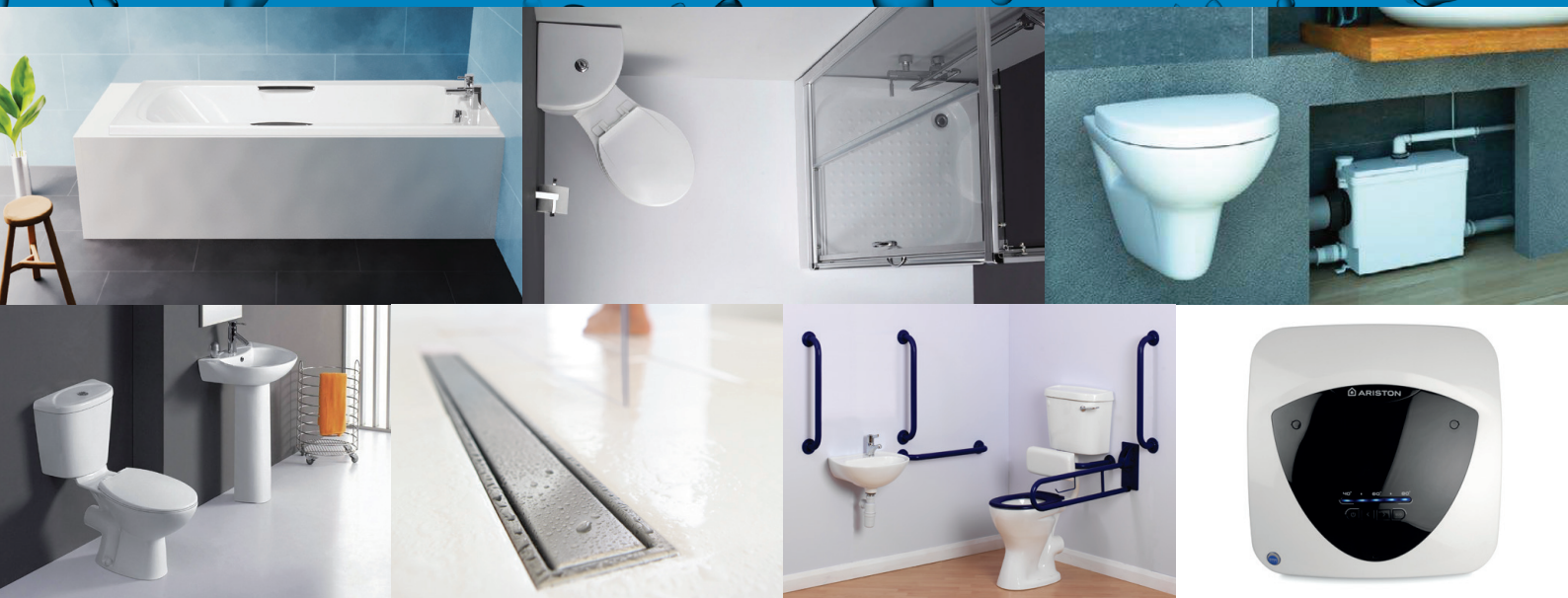

## THE COMMERCIAL COLLECTION

APRIL 2021

# CONTENTS



GEORGIA / ELITE	04	STAINLESS STEEL WASTES	28
GEORGIA / KOSMO	06	FLEXI-SEAL / BONDMASTER	30
GALAXY / TARA	07	WET ROOM SCREENS	31
VANITY BASINS	08	LEAK FREE SHOWERING	32
VESSELS	09	SHOWER VALVES	34
iCARE	10	SHOWERING ACCESSORIES	39
iCARE ACCESSORIES	12	BATHS	40
FREEDOM DOOR RANGE	14	STEEL BATHS	42
BABY CHANGING UNIT	16	LESS ABLED BATHS	43
CLEANER SINK	17	BATH PANELS	44
URINALS	18	BRASSWARE	45
WALL HUNG SYSTEMS	20	VICTORY VALVES	51
PUSH PLATES	21	BASIN / BATH WASTES	52
CISTERNS	22	BOTTLE TRAPS	53
TRAPS	24	SANIFLO	54
iCON FANS	25	GRUNDFOS PUMPS	65
SEATS	26	ARISTON	68



**R.T. LARGE**

ESTABLISHED 1969

# GEORGIA / ELITE

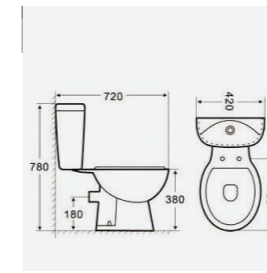

**Georgia Pan**  
Includes Seat & Cover

CODE CGEOCCPAN

**Georgia Cistern**

CODE CGEOTANK

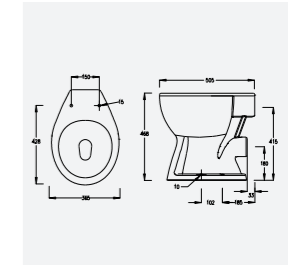

**Elite Back To Wall Pan**  
Seat / Cover Not Included

CODE UBTW002

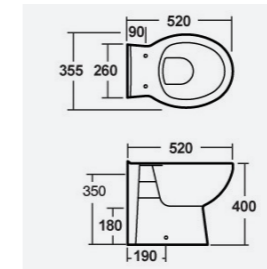

**Elite Low Level High Pan Only**  
Seat / Cover Not Included

CODE ELPANLLHIGH

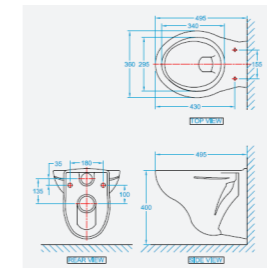

**Galaxy Wall Hung Pan Only**  
Seat / Cover Not Included

CODE ELPANWH

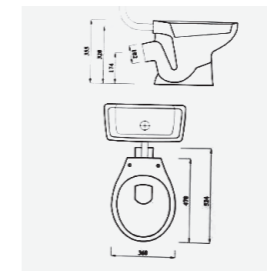

**Elite Junior Pan Only**  
Seat not included

CODE ELPANJUN + SCR12WH

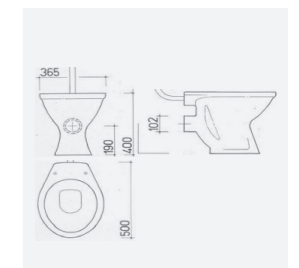

**Elite BS Low Level Pan**  
Seat & Cover not included

CODE ELPANLL



**Elite Infant Pan Only**  
Seat not included

CODE ELPANINF + SCJ53WH

**Elite BS Low Level Cistern (Bottom Inlet)**

CODE ELTANLLB

**Elite BS Low Level Cistern (Side Inlet)**

CODE ELTANLLS

# GEORGIA / KOSMO



**Georgia  
545 2TH Basin**

CODE CGEOBAS5252TH

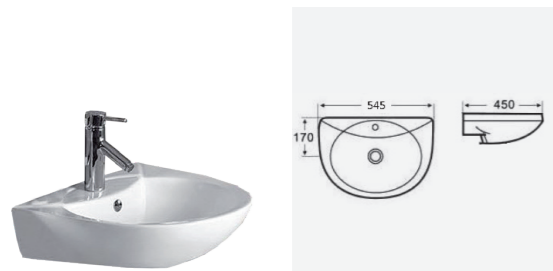

**Georgia  
545 1TH Basin**

CODE CGEOBAS5251TH



**Kosmo  
BS 450 2TH Basin**

CODE CKOSBS452TH



**Kosmo  
BS 450 1TH Basin**

CODE CKOSBS451TH

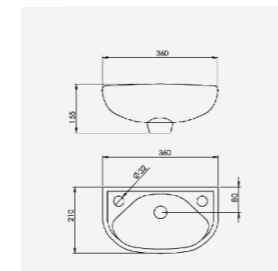

**Elite  
Basin 355x255 2TH**

CODE ELBAS3552TH

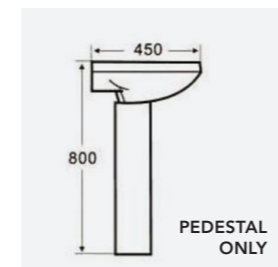

**Georgia  
Full Pedestal Only**

CODE CGEOPED

**Heavy  
Duty  
Basin  
Bracket**

Note: may be used as an alternative to a pedestal.

CODE IBASINBRKSP



# GEORGIA / GALAXY

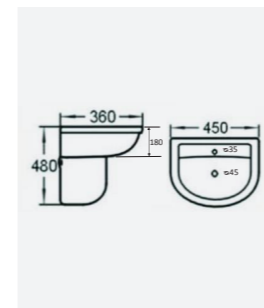

**Kosmo  
Semi Pedestal Only**

CODE CKOSPEDS

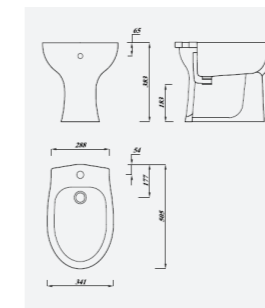

**Elite  
Bidet**

CODE ELBIDET

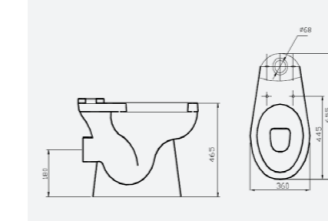

**Georgia Comfort  
Pan Pack  
Cistern & Soft Close  
Seat Included**

CODE CGEOCCPANH

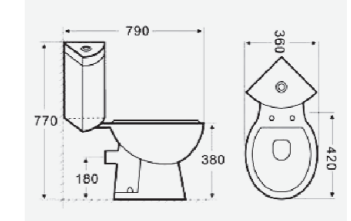
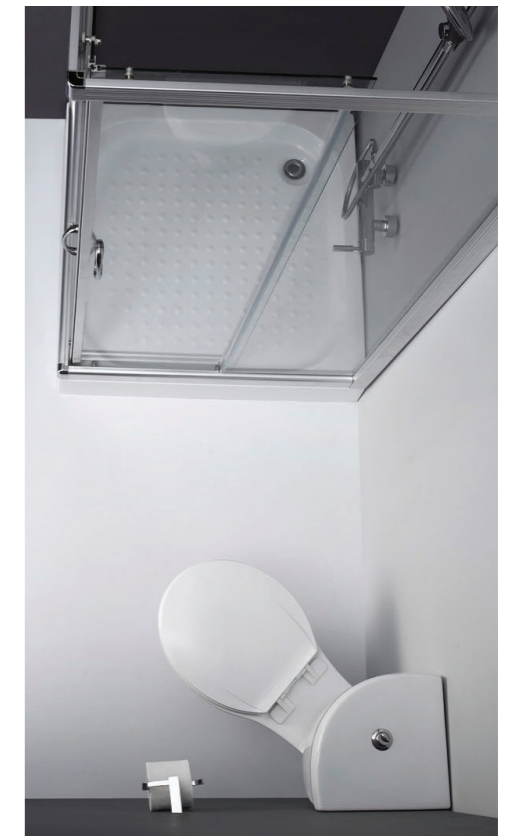

**Galaxy Corner Pan  
Seat / Cover Not Included**

CODE CGALCORPAN

**Galaxy CC Corner  
Dual Flush Cistern**

CODE CGALCORTANK

# VANITY BASINS

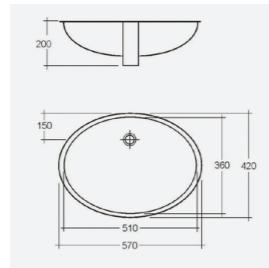

**Galaxy Under Counter**  
570mm x 420mm  
CODE CGALUNDER

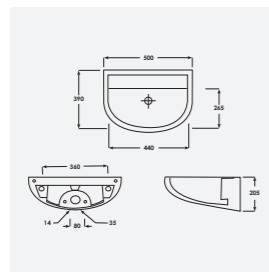

**Horizontal Outlet Wash Basin**  
540mm x 420mm  
CODE RCOM50NBAS

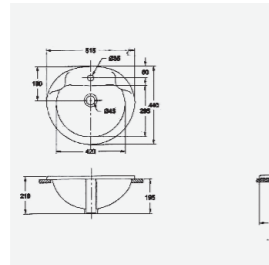

**June Vanity Basin 1TH**  
510mm x 435mm  
CODE BAHJUNEB1

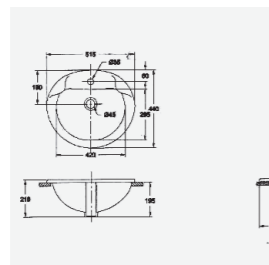

**June Vanity Basin 2TH**  
510mm x 435mm  
CODE BAHJUNEB2

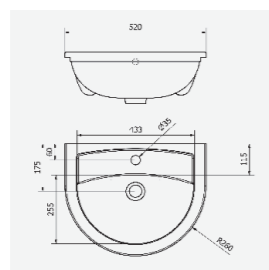

**Kosmo Semi Recess Basin 1TH**  
CODE CKOSBSREC1TH

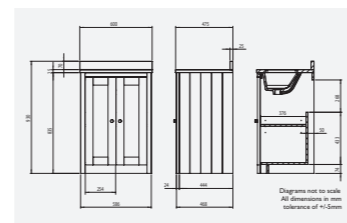

**Lansdown Underslung Basin**  
600mm x 475mm  
- No overflow

CODE TAVLANUSBAS

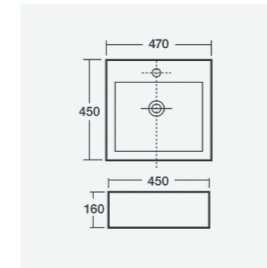

L: 470mm  
W: 450mm  
H: 160mm  
CODE UNBV102

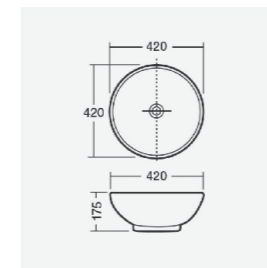

L: 420mm  
W: 420mm  
H: 175mm  
CODE UNBV124

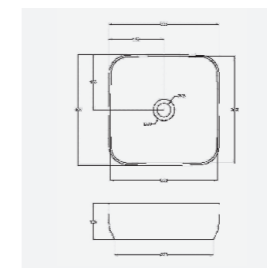

L: 365mm  
W: 365mm  
H: 120mm  
- No overflow  
CODE UNBV163

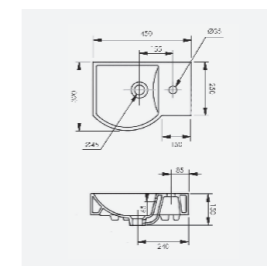

**Blend**  
L: 305mm  
W: 450mm  
H: 105mm  
- Bottle trap supplied separately  
CODE TAVMIA450C

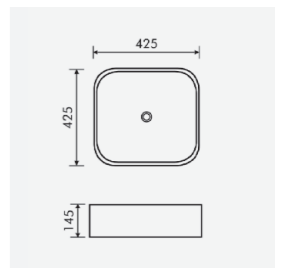

**Estante**  
425mm x 425mm  
- No overflow  
CODE EST42BAS

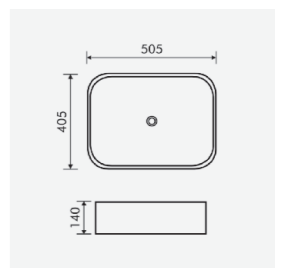

**Estante**  
505mm x 405mm  
- No overflow  
CODE EST50BAS

# iCARE

Our iCare Doc M Packs are suitable for both domestic and commercial applications.

Specifically designed to meet the requirements of Building Regulations document M, all iCare Doc M Packs carry full LABC Approval (local Authority Building Control). Each pack comprises of 470mm raised height WC push button or lever cistern, wash basin & brackets, 5 x 600mm Grab Rail Pack, swing arm, sequential mixer, seat ring, bottle trap, waste and padded back rest for low level packs. CE compliant and fully WRAS approved. Each pack is available with white, blue, black or stainless steel grab rail options.

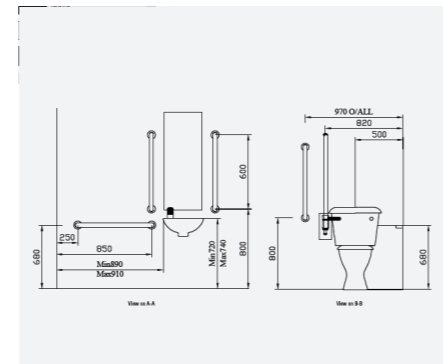

**Lantac Close Coupled**  
- White Rails

CODE IDOCPKCC

**Lantac Close Coupled**  
- Pantone 5011 Blue Rails\*

CODE IDOCPKCCBLUE



**Pantone 5011 Blue**

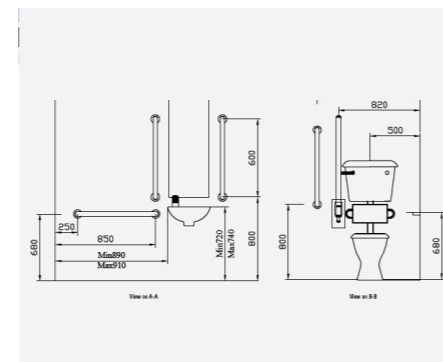

**Lantac Low Level**  
- White Rails

CODE IDOCPK

**Lantac Low Level**  
- Pantone 5011 Blue Rails\*

CODE IDOCPKBLUE

\*Please Note - Pantone 7005 Grey, Black and Stainless Steel rails are available on request.



**iCare Close Coupled WC Pan**

W: 362mm  
D: 670mm  
H: 510mm

CODE IDOCCPAN

**iCare Comfort Cistern With Push Button**

W: 456mm  
D: 195mm  
H: 367mm

CODE IDOCCTANKPB

**iCare Comfort Cistern With Spatula Lever**

W: 456mm  
D: 195mm  
H: 367mm

CODE IDOCCTANK

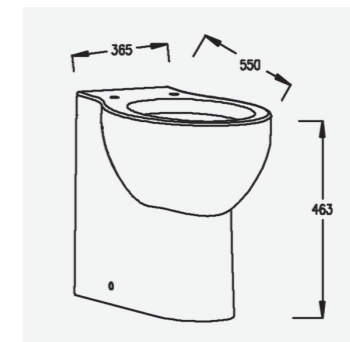

**iCare Back to Wall Pan**

W: 360mm  
D: 553mm  
H: 472mm

CODE IDOCBTWPAN



**iCare Soft Close Seat**

- Lightweight cost-efficient soft close seat and cover
- Plastic hinge mechanism
- Lateral movement buffers as standard

CODE IDOCSEAT

# iCARE ACCESSORIES

## STANDARD SEATS



**iCare Shower Seat**

CODE ICAREGREY



**iCare Shower Seat 2**

CODE ICAREGREY2



**Shower Seat**

CODE ECSEAT1



**Free Standing Seat**

CODE ECSTOOL



**Slatted Shower Seat**

CODE ECSEAT2



**Raised Toilet Seat**

CODE DDB632A

## GRAB BARS AND RAILS



**Metal Range White**  
(35mm Diameter)

**300mm Rail**

CODE BG300W

**450mm Rail**

CODE BG450W

**600mm Rail**

CODE BG600W

**Back Rest**

CODE BGBACKW



**Plastic Gripper Range**  
**White** (35mm Diameter)

**300mm Rail**

CODE BG300PLA

**450mm Rail**

CODE BG450PLA

**600mm Rail**

CODE BG600PLA



**Metal Range (35mm Dia.)**  
**Pantone 5011 Blue\***

**300mm Rail**

CODE BG300B

**450mm Rail**

CODE BG450B

**600mm Rail**

CODE BG600B



**Stainless Steel Range**  
(25mm Diameter)

**300mm Rail Stainless Steel**

CODE BG300SS

**600mm Rail Stainless Steel**

CODE BG600SS



**White Hinged Arm**

CODE BGHINGW

**White Hinged Arm with Leg**

CODE BGHINGLEGW



**Stainless Steel Hinged Arm**

H: 300mm W: 100mm D: 850mm

CODE AP502841

**Stainless Steel Hinged Arm / Leg**

H: 710mm W: 100mm D: 850mm

CODE AP502941



**Pantone 5011 Blue\* Hinged Arm**

H: 300mm W: 100mm D: 850mm

CODE BGHINGB



**Stainless Steel Grab Bars - Chrome**  
(32mm Diameter)

**300mm Straight Rail** (300mm x 82mm)

CODE AP506105

**450mm Straight Rail** (450mm x 82mm)

CODE AP506205

**600mm Straight Rail** (600mm x 82mm)

CODE AP506305

**600mm Angled Rail** (600mm x 82mm)

CODE AP506405

\*Please Note - Pantone 7005 Grey arms are available on request

# FREEDOM DOOR RANGE

## Features of the Freedom Shower Door

- 360 degree hinge
- 180 degree rise & fall hinge
- PETG safety Panels
- White powder coated aluminium
- Magnetic Closing Seal
- CE approved

## Benefits of the Freedom Shower Door

Due to our unique 360 degree hinge system our shower doors provide the following benefits;

- No Handing Required
- Easy to install
- Simple to use
- Maximum Accessibility



Tri-fold Option Shown



Tri-fold Option Shown



### Locking Mechanism

Locking Door Catch with magnetic closing seal as standard.



### Rise and Fall

180 degree, rise and fall, double seal hinge with extra adjustable seal at the bottom and 20mm adjustable wall profile.



### 360 Degree Hinges

360 degree hinges to allow extra flexibility in confined spaces.

## FREEDOM SHOWER DOOR CONFIGURATIONS - Note these configurations are shown on a right hand tray

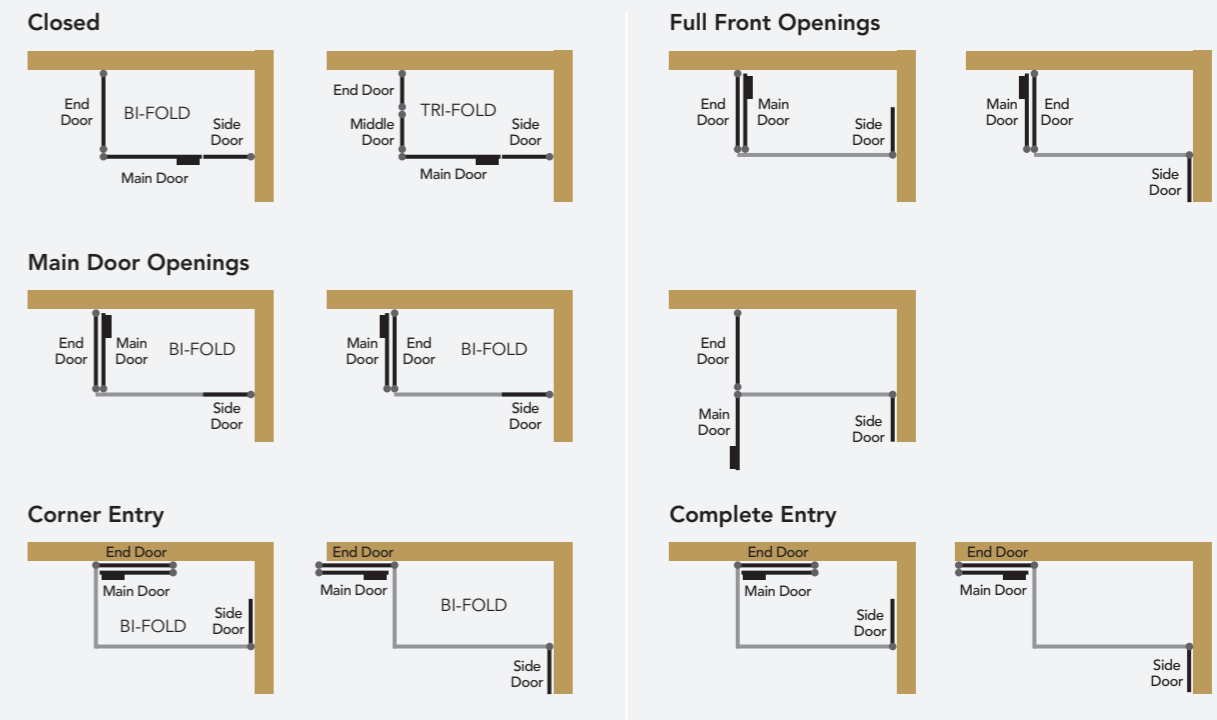

## DOORS ONLY

650mm x 1085mm - Bi-fold 360 Door	CODE SCDOOR650
750mm x 1075mm - Bi-fold 360 Door	CODE SCDOOR750
850mm x 1170mm - Bi-fold 360 Door	CODE SCDOOR850
900mm x 900mm - Bi-fold 360 Door	CODE SCDOOR900
1000mm x 1000mm - Tri-fold 360 Door	CODE SCDOOR1000

## TRAYS ONLY

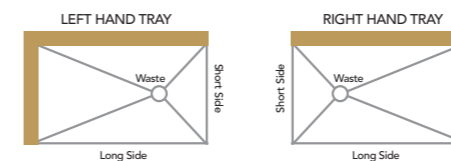

720mm x 1165mm - Left Hand	CODE SCTRAY650LH
720mm x 1165mm - Right Hand	CODE SCTRAY650RH
830mm x 1165mm - Left Hand	CODE SCTRAY750LH
830mm x 1165mm - Right Hand	CODE SCTRAY750RH
930mm x 1270mm - Left Hand	CODE SCTRAY850LH
930mm x 1270mm - Right Hand	CODE SCTRAY850RH
960mm x 960mm	CODE SCTRAY900
1070mm x 1070mm	CODE SCTRAY1000

## KITS

650mm x 1085mm Left Hand Kit	CODE SCKIT650LH
650mm x 1085mm Right Hand Kit	CODE SCKIT650RH
750mm x 1075mm Left Hand Kit	CODE SCKIT750LH
750mm x 1075mm Right Hand Kit	CODE SCKIT750RH
850mm x 1170mm Left Hand Kit	CODE SCKIT850LH
850mm x 1170mm Right Hand Kit	CODE SCKIT850RH
900mm x 900mm Kit	CODE SCKIT900
1000mm x 1000mm Kit	CODE SCKIT1000



# BABY CHANGING UNIT



## Baby Changing Unit - Horizontal

406mm (h) x 870mm (w) x 457mm (when fully extended)

- Complies to BSEN12221-1:2008
- Easy to clean, high density polyethylene inhibits bacterial growth
- Holds up to 50 liners per unit
- Convenient bag hooks on both sides
- Compact, slim profile, protrudes only 120mm from the wall
- Safety belt with cam buckle is adjustable with one hand
- Holds up to 110kg when properly installed
- Easy to read A.N.S.I. compliant labels

CODE BABYCHG

# HAND DRYER

## Electric Hand Dryer

H: 325mm  
W: 295mm  
D: 171mm

- Rated Voltage - AC220-240V
- Rated Frequency - 50/60HZ
- Rated Power - 1800W
- Motor Power - 600W
- Ambient Temperature 0-40°C
- Way of Heating - Heating Wire
- Waterproof Grade - IPX1
- Wind Speed - 90m/s
- Sensing Distance - 9-15cm
- Drying Time - 7-12 seconds
- Installation - Wall Mounting

CODE AVH600

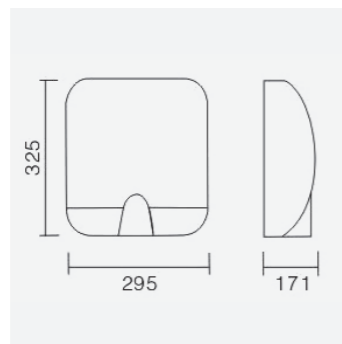

# CLEANER SINK



## Cleaner Sink Including grill kit

CODE RCLEANER

## Stainless Steel Cleaner Sink Stand Height 450mm

CODE RCLEANSTAND

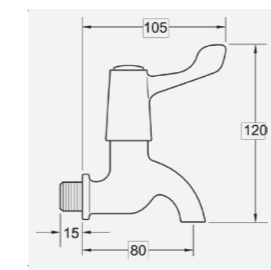
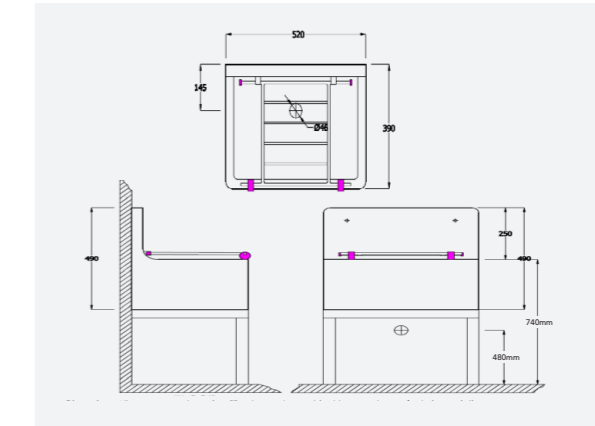

## 3" Lever Bib Taps (Pair)

CODE SHA701L

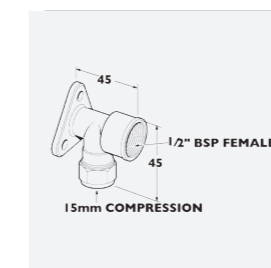

## Back Plate Bracket (Pair)

CODE SHABRA

# URINALS

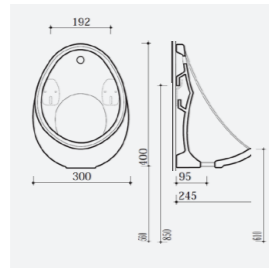

**400 Urinal**  
H: 400mm x W: 300mm

- 1 ¼" PVC waste,
- Brackets supplied in box
- Exposed Waste

CODE URI400

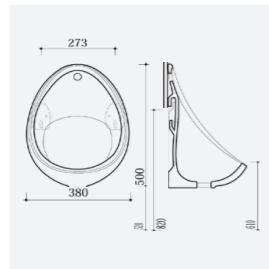

**500 Urinal**  
H: 500mm x W: 380mm

- 1 ¼" PVC waste,
- Brackets supplied in box
- Exposed Waste

CODE URI500

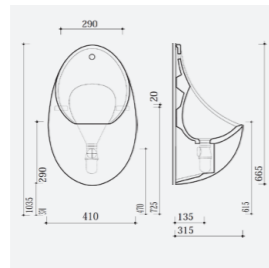

**600 Urinal**  
H: 665mm x W: 410mm

- 1 ½" PVC waste,
- back inlet spreader and brackets supplied
- Concealed waste

CODE URI600

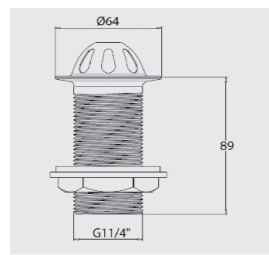

**1 ¼ SS Urinal Waste**  
- Suitable for 400 and 500 urinal

CODE WUSS01SS

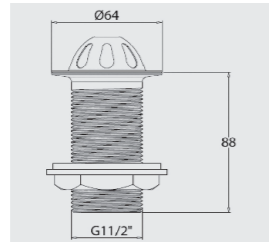

**1 ½ SS Urinal Waste**  
- Suitable for 600 urinal

CODE WUSS02SS

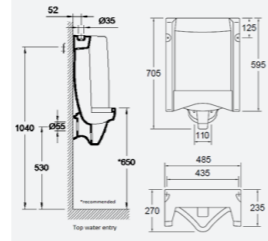

**Florida Top Inlet Urinal**  
H: 703mm x W: 485mm

- Integrated spreader and waste
- Waste fixing kit and brackets included

CODE FLORIDATI

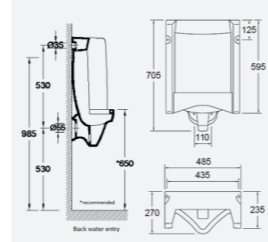

**Florida Back Inlet Urinal**  
H: 705mm x W: 485mm

- Integrated spreader and waste
- Waste fixing kit and brackets included

CODE FLORIDABACK

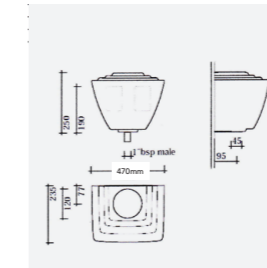

**Ceramic Urinal Header Tank**  
13 Litre  
Auto Ceramic Cistern

CODE BAHURCI13

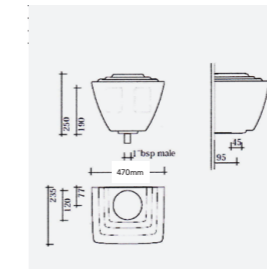

**Ceramic Urinal Header Tank**  
9 Litre  
Auto Ceramic Cistern

CODE BAHURCI9

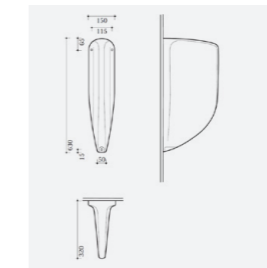

**Urinal Divider**

CODE URIDIVID

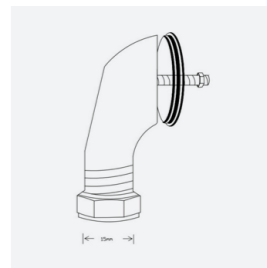

**Top Inlet Spreader**

CODE UST43CP



**Back Inlet Spreader**

CODE USB38CP

## SPARGE PIPES



**Sparge Pipes**  
- Set of 1

CODE UFA01CP



**Sparge Pipes**  
- Set of 2

CODE UFB22CP



**Sparge Pipes**  
- Set of 3

CODE UFC22P



**Sparge Pipes**  
- Set of 4

CODE UFD22CP

See page ?? for PVC Cisterns.

# WALL HUNG SYSTEMS

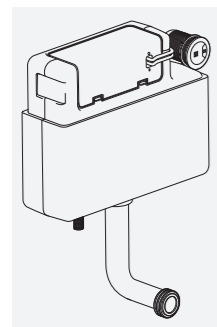

## Vortex Dual Flush Cistern

- Button Included
- 6/3 litre adjustable dual flush
- Pneumatic flush valve
- Chrome push button included
- Bottom entry inlet valve (1/2" BSP)
- Top & front access
- 0.2-10.0bar working pressure range
- 200,000 cycle endurance tested
- 135mm deep - designed to work with low height & slim depth furniture
- Includes polystyrene insulation jacket

CODE TAVVOR790

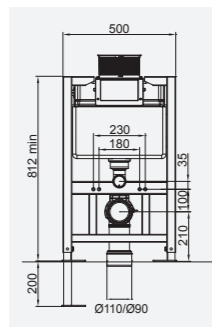

## Vortex 0.81m Wall Hung Frame

- Flush Plate Not Included
- 0.82m high for use within 600mm and wider furniture WC units
- 500mm width
- Adjustable depth 167-215mm
- Adjustable height legs (200mm adjustment)
- 6/3L pneumatic flush valve
- Side entry 1/2" BSP (female) inlet valve connection
- Front or top access panel for maintenance
- Polystyrene anti-condensation jacket
- 0.2-10.0bar working pressure range
- Brackets, fixings and 1st fix protective covers included

CODE TAVTR9005

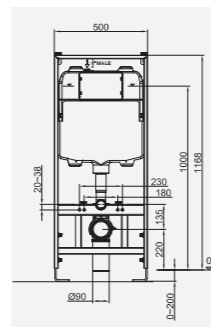

## Vortex 1.17m Wall Hung Frame

- Flush Plate Not Included
- 1.17m high for in-wall applications
- 500mm width
- Adjustable depth 140-200mm (for side or floor exit pipe runs), 110mm min depth if pipe work routed straight through wall
- Adjustable height legs (200mm adjustment)
- 6/3L pneumatic flush valve
- Top entry 1/2" BSP (male) inlet valve connection
- Front access panel for maintenance
- Polystyrene anti-condensation jacket
- 0.2-10.0bar working pressure range
- Brackets, fixings and 1st fix protective covers included

CODE TAVTR9006

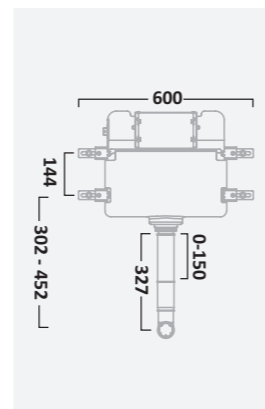

## In Wall Cistern

Flush Plate Not Included

CODE TAVVR9009



# FLUSH PLATE OPTIONS

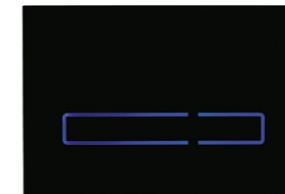

Sensor Flush Plate  
Black with Blue LED

CODE TAVTR9016

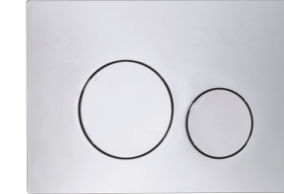

Circles Flush Plate -  
Chrome

CODE TAVTR9012

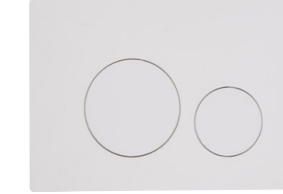

Circles Flush Plate -  
White

CODE TAVTR9013



Square Flush Push  
Plate - Chrome

CODE TAVTR9010



Square Flush Push  
Plate - White

CODE TAVTR9011

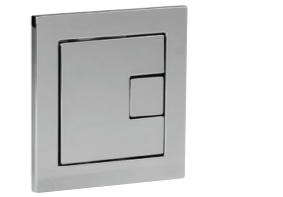

Square Dual Flush  
Button CP

CODE TAVTR9003



Contactless Flush  
Remote Sensor Kit

CODE TAVTR9014



Square Flush Plate -  
Black

CODE TAVTR9020



Circles Flush Plate -  
Black

CODE TAVTR9021



Dual Flush  
Button CP

CODE TAVTR9004



Round Flush Button -  
Black

CODE TAVTR9022



Square Flush Plate -  
Stainless Steel

CODE TAVTR9019



Traditional Flush  
Plate - Chrome

CODE TAVTR9017

# CISTERNS

## FITTINGS

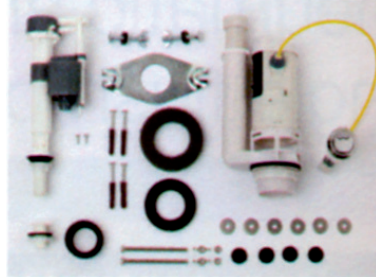

### Universal Bottom Entry Cistern Fittings

- Easy fit water saving flush valve
- Multi full and part flush settings
- Internal overflow
- Adjustable overflow making it ideal for both new and retrofit installations
- Removeable top for cleaning and replacement
- Comes complete with chrome finish dual flush button and bezel
- Complete flushing kit option available as a one stop solution for trade
- Tested to 200,000 cycles and pending approval
- Suitable for converting lever cistern to Dual Flush



CMEAV068

## CISTERNS

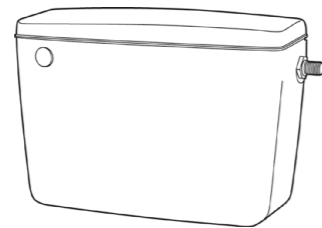

### Elan

Size: W: 455mm x H: 318mm x D: 155mm

Auto siphon, petcock inlet,  
1 gallon/4.5l, suitable for 1 bowl

CODE CFE09WH

Auto siphon, petcock inlet,  
2 gallon/9l, suitable for 2 bowls

CODE CFE10WH

Auto siphon, petcock inlet,  
3 gallon/13.6l, suitable for 3 bowls

CODE CFE08WH

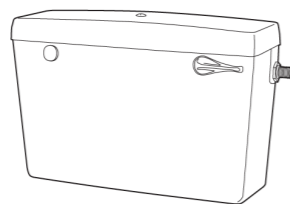

### Elan

Size: W: 505mm x H: 327mm x D: 150mm

Low level, side entry inlet, adjustable flush volumes

CODE CFE41WH

Low level, bottom Entry inlet,  
adjustable flush volumes

CODE CFE51WH

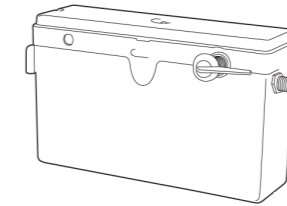

### Hideaway

Size: W: 505mm x H: 312mm x D: 146mm

Concealed cistern, single flush,  
side entry inlet, adjustable flush volumes

CODE CFH14CP

Concealed cistern, dual flush,  
side entry inlet, adjustable flush volumes

CODE CFH14DF

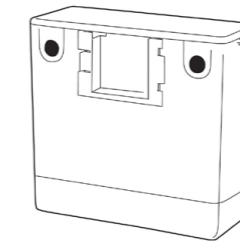
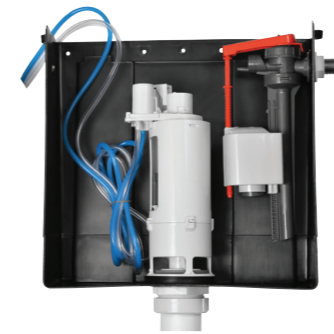

### Pneu Compact II

Size: W: 336mm x H: 320mm x D: 140mm

Pneumatic operated flush mechanism,  
dual flush, side entry Jollyfill

CODE CPL61CP

Caspia Dual Flush Plate, chrome

CODE SYG612CP

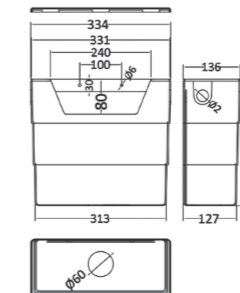

### Compact Concealed Cistern

Size: W: 334mm x H: 303mm x D: 136mm

Cable Operated, Comes with Push  
Button, Side entry inlet

CODE UXTY006

## CISTERN LEVERS



Doc M  
Cistern Lever

CODE DCA.52



Standard Metal  
Cistern Lever

CODE RE355



12" Cistern  
Extension Lever

CODE RE356



Ceramic  
Lever

CODE UE370

# TRAPS



**Straight Connector**  
CODE PPC02WH



**90 degrees**  
CODE PPC07WH



**40mm Offset**  
CODE PPC13WH



**90 degrees + Boss**  
CODE PPW07WH



**Bath Trap 40mm Seal**  
CODE PWT5800



**'P' Trap 32mm**  
CODE PWT5000



**'S' Trap 32mm**  
CODE PWT5400



**Swan**  
CODE PPC12WH



**Flex**  
CODE FLEXPANCOSH

**'P' Trap 40mm**  
CODE PWT5100

**'S' Trap 40mm**  
CODE PWT5500



**Pedestal**  
CODE PBT0100



**90° Flexible Bend**  
CODE FLEXI90DEG



### Motion

- Unique all-in-one universal dual flush siphon
- Wide range of height options
- Fastest flush rate on the market

CODE W10120045



**Jollyfill Inlet valve**  
CODE W16110101



**Kayla Flush Valve**  
Suitable for 1½" or 2"  
CODE WDVA0100



**Jollytronic**  
- No touch flushing  
hygienic  
- Battery operated  
CODE W10120021



**Wirquin One Dual Flush Valve**  
- Flush rate of 2,4L/Sec  
- Fast installation  
CODE W10120440

# iCON FAN RANGE

The iCON range offers a stylish and innovative approach to ventilation. The unique 'iris' system operates by opening and closing as required. This greatly reduces back draft and external noise ingress.

The units come in three variations; iCON15, iCON30 and iCON60 which are customised for various applications as can be seen in the table below. All units come as standard in a white finish with the option to upgrade from a choice of finishes and control module options. Note that the iCON range has been designed to provide ventilation levels that meet the latest Building Regulations ADF.

### FEATURES

- Conforms to IPX4 rating
- Range of finishes available
- Stylish, slim and unobtrusive in walls or ceilings
- Unique iris shutter, prevents back draughts, operates silently
- Interchangeable control modules match fan to installation requirements
- Circular design, no squaring up
- Very simple installation
- 3 year warranty



DESCRIPTION	CODE
iCON 15	FANIC15
iCON 30	FANIC30
iCON 60	FANIC60
iCON 15 Anthracite - Cover	FANICVA15
iCON 30 Anthracite - Cover	FANICVA30
iCON 15 Chrome - Cover	FANICVC15
iCON 15 Silver - Cover	FANICSV15
iCON 30 Silver - Cover	FANICSV30
Pull Cord - Module	FANPCM
PIR, Humidity, Timer - Module	FANPRHTM
PIR, Timer - Module	FANPRTM
Adjustable Timer - Module	FANTM
Humidity, Pull Cord, Timer - Module	FANHTM

**iCON®**



# SEATS



## International

- Lightweight & cost-effective
- Manufactured from durable polypropylene material
- Supplied with adjustable plastic hinges
- Designed to fit modern sanitaryware from leading UK & European suppliers

CODE SNL11WH



## Standard Soft Close Seat

- Lightweight cost-efficient soft close seat and cover
- Plastic hinge mechanism

CODE UNTS010



## Foster White Toilet Seat with Soft Close

- Adjustable hinges fit all standard toilets
- Hard wearing thermoset plastic
- Chrome plated hinges
- Practical soft-close hinge stops the lid from slamming
- Toilet seat hinges can be adjusted to suit fixing hole centres from 100mm to 200mm
- All fittings included

CODE CRWL601722H



## Nadix

- Thermoset material
- Stainless steel mounting
- Universal hinge
- Ergonomically designed dish cover
- Seat & Cover including stainless steel hinge

CODE SNX11WH



## Casabella Soft Close

- Size 450 x 375 mm
- Soft close action on seat and lid
- Easy lift off
- Top-fixing with metal hinge mechanism

CODE SCSOFTCL



## iCare Soft Close Seat

- Lightweight cost-efficient soft close seat and cover
- Plastic hinge mechanism

CODE IDOCSEAT



## Crescent

- Thermoset material in white
- Suitable for almost any WC pan
- For 14" and 16" pans

CODE SCR12WH - Adult Seat & Cover - S/Steel Hinges

CODE SCJ53WH - Junior Seat Only - S/Steel Hinges



## Celmac Celeste Plus

The Celeste Plus is designed to have the features and benefits of a Doc M Seat whilst keeping the look and feel of a quality standard toilet seat, making it suitable for use in the home as well as a hospital or care home environment.

- Heavyweight seat option
- Manufactured using Halo™ anti-viral/bacterial material, ideal for hospitals and care homes
- Sturdy chrome plated brass hinges
- Ergonomically designed seat for maximum comfort
- Adjustable locating buffers which eliminate lateral movement in the seat

CODE SCK11WY



## Delta D Shaped Toilet Seat - White

- W: 370mm x D: 455mm
- OEM replacement toilet seat
- Highly durable thermoset material
- Hard wearing and impact resistant
- Designed to fit most toilet pans
- Soft close hinges
- Single button quick release for ease of cleaning
- Top & under fixings

CODE TAV8903WSC



## Nova D Shaped Toilet Seat

- W: 370mm x D: 435mm
- OEM replacement toilet seat
- Highly durable thermoset material
- Hard wearing and impact resistant
- Designed to fit most toilet pans
- Soft close hinges
- Quick release for ease of cleaning
- Top & under fixings

CODE CNOVASEAT

# STAINLESS STEEL WASTES



#### 150mm x 150mm Horizontal Trap

- High flow rate
- Suitable for 1½" solvent pipe
- Complete with connection adapter

CODE FD1515



#### 150mm x 150mm Horizontal Trap

- With tiling flange
- High flow rate
- Suitable for 1½" solvent pipe
- Complete with connection adapter

CODE FD1515F



#### Channel Waste

- All 304 stainless steel
- Removable Easy-Clean water trap
- Flow Rate: 35L/min
- Complete with connection adapter
- Width 100mm, available in lengths: 500mm - 1000mm

100 x 500mm CODE FD10500

100 x 600mm CODE FD10600

100 x 700mm CODE FD10700

100 x 800mm CODE FD10800

100 x 900mm CODE FD10900

100 x 1000mm CODE FD101000

Contact our sales department  
for additional information

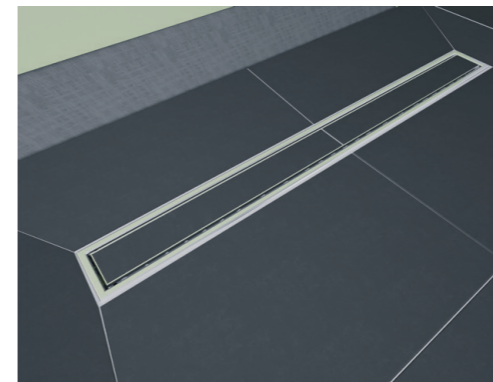

#### Venisio Expert by Wirquin

- Choice of stainless steel grid or tiled
- Ultra high flow rate: up to 79L/min (under 20mm of water)
- Reduced dimensions: 89mm below floor
- 50mm water seal
- Reversible finish grid:  
Brushed stainless steel or tile finish
- Self contained trough with trap:  
direct access to the trap from above
- Supplied with waterproofing sheet:  
secured by adhesion and screws to ensure a watertight seal
- Perfect finish: stainless steel grid and frame to prevent corrosion
- Height adjustable: even after tiling has been completed
- Suitable for tile depth between 8mm & 16mm
- Channels water to waste to prevent delamination of tiles

80 x 700mm CODE WIR30718077

80 x 800mm CODE WIR30718078

80 x 900mm CODE WIR30718079

80 x 1100mm CODE WIR30718606



**wirquin**



# FLEXI-SEAL

Use Flexi-Seal to protect floors and ceilings from expensive water damage caused by leaks from shower trays, baths and work surfaces.

Flexi-Seal uses a combination of a durable flexible rubber with a waterproof butyl based adhesive to give maximum protection between the application surface and tiles or panels.

Since the rubber is flexible, it will maintain a watertight seal whilst allowing for a certain amount of movement that is inevitable, particularly with new builds.

Available in 2m, 3m, 4m, 10m & 20m rolls.



PROTECTS AGAINST WATER DAMAGE CAUSED BY LEAKS

CODE TFLEXI2	2m
CODE TFLEXI3	3m
CODE TFLEXI4	4m
CODE TFLEXI10	10m
CODE TFLEXI20	20m

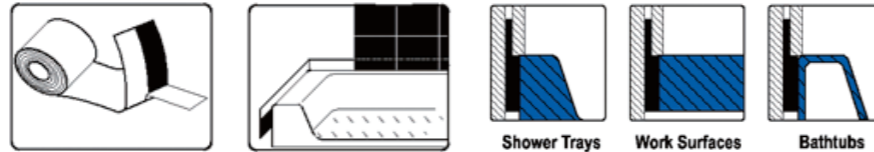

Shower Trays Work Surfaces Bathtubs

# BONDMASTER TANKING SYSTEM



- Kit for tanking shower rooms
- Contains Tilers Primer, Polyester Joint Tape, Waterproof Liquid Membrane & Polyester Matting
- Used prior to fixing ceramic wall tiles
- Ensures a water tight barrier preventing water penetration
- Suitable for use on a wide variety of surfaces including concrete, cement-sand rendering, plaster, plasterboard and moisture stable timber boards
- Not recommended for outdoor use
- Covers 6sq metres

CODE WFTANK6

# CASANUOVA WETROOM PANELS



Casanuova 300 Wet Room Flipper Panel	Code CNVWR300
Casanuova 700 Wet Room Panel	Code CNVWR700
Casanuova 800 Wet Room Panel	Code CNVWR800
Casanuova 900 Wet Room Panel	Code CNVWR900
Casanuova 1000 Wet Room Panel	Code CNVWR1000
Casanuova 1200 Wet Room Panel	Code CNVWR1200

## OPTIONAL BRACKETS & ACCESSORIES

Casanuova Wet Room Panel Extra Height Support Arm	Code CNVWRSUP
Casanuova Wet Room T-Piece for End Panel	Code CNVWRT
Deluxe Squeegee	Code CROAJ401641

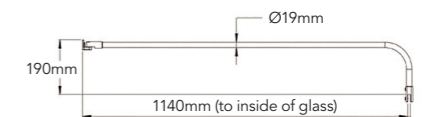

## Features:

- 8mm toughened glass
- 1900mm high
- Easy clean glass
- Hinged deflector panel
- 1m support bar
- T-Piece for end panel support
- Additional height support bar



10 YEAR WARRANTY





# LEAK FREE SHOWER CUBICLES



## Moonlight Quad Slider

- Shower valve not included
- Suitable for fitting electric shower
- Cristalplus glass to reduce limescale build up

CODE CA118A12GB

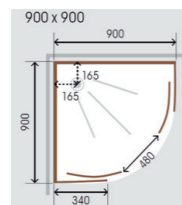

## Moonlight 1100 x 800mm

- Shower valve not included
- Suitable for fitting electric shower
- Cristalplus glass to reduce limescale build up

CODE CA1197A12GB

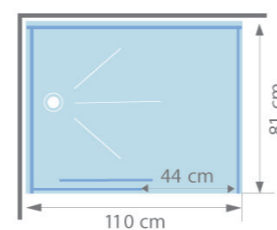

## Moonlight 900 x 900mm

- Shower valve not included
- Suitable for fitting electric shower
- Cristalplus glass to reduce limescale build up

CODE CA11A12GB

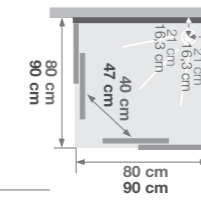

## Moonlight 800 x 800mm

- Shower valve not included
- Suitable for fitting electric shower
- Cristalplus glass to reduce limescale build up

CODE CA116A12GB



## Consort

- Inward open saloon style Styrene doors
- 815mm x 815mm x 2020mm
- Suitable for fitting electric shower
- Suitable for fitting against one wall or into a corner
- Shower valve not included

CODE CA10GB

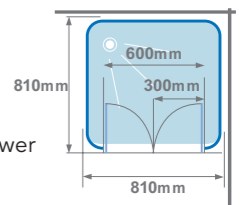

# COMMERCIAL SHOWER VALVES

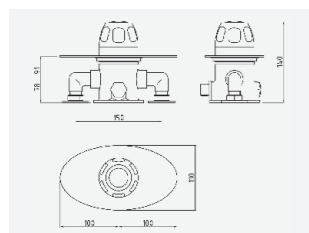

## Sequential Thermostatic Lever Shower Valve & Slide Rail Exposed

- Including 1 metre slide rail kit and 2 metre hose

CODE KITVSQ2

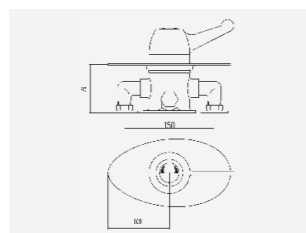

## Sequential Thermostatic Valve Concealed

CODE UVSQ4

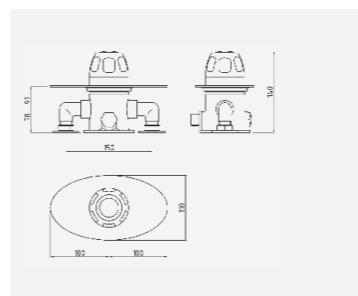

## FEATURES

- Sequential control shower valve for combined control of temperature and flow
- Suitable for use with unvented supplies, combi boilers, gravity and mains pressure systems
- Single-piece thermal cartridge technology
- Factory set at 43°C to prevent scalding
- Temperature stability of +/-2°C
- Failsafe on hot and cold supplies
- Operating pressure range of 0.1 to 10 bar

CODE KITVSQ2

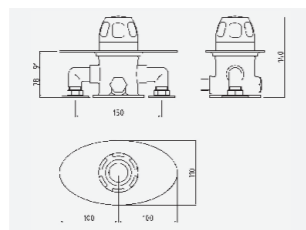
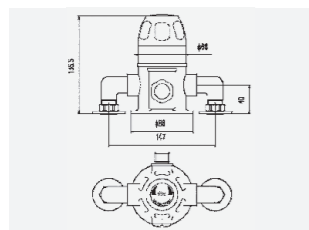

## Sequential Thermostatic Shower Valve Concealed

CODE UVSQ3

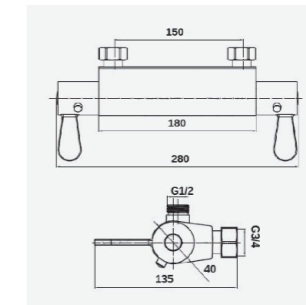

## TMV3 Bar Shower Valve

- WRAS Approved

CODE AVUT69

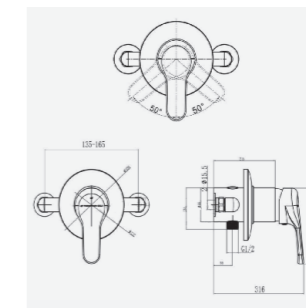

## Single Lever Thermostatic Shower Valve

- WRAS Approved
- Can be used concealed or exposed

CODE ALAVALTH

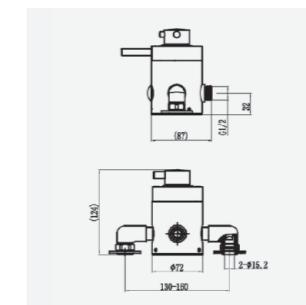
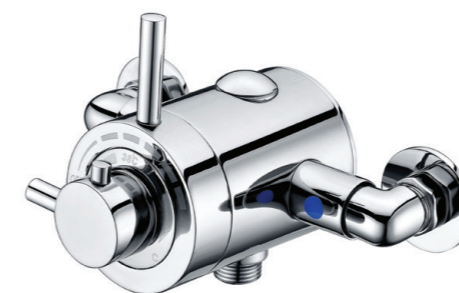

## Dual Lever Thermostatic Shower Valve

- WRAS Approved
- TMV3
- Adjustable centres 130-160mm
- 1/2" connection
- Can be used concealed or exposed

CODE VM61P



ADJUSTABLE CENTRES AS A FEATURE

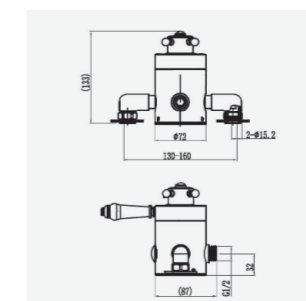

## Traditional Lever Thermostatic Shower Valve

CODE VM91P



ADJUSTABLE CENTRES AS A FEATURE

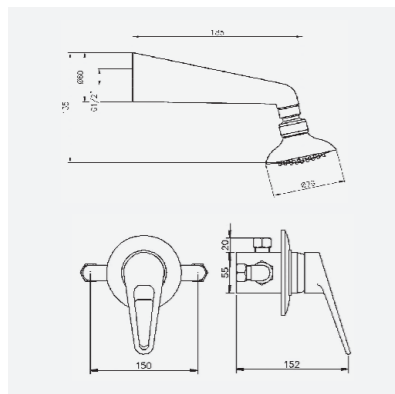

**Alpha Shower Kit 2**

- 15mm Manual valve including single function fixed head
- Suitable for concealed installation

CODE ALAKIT2

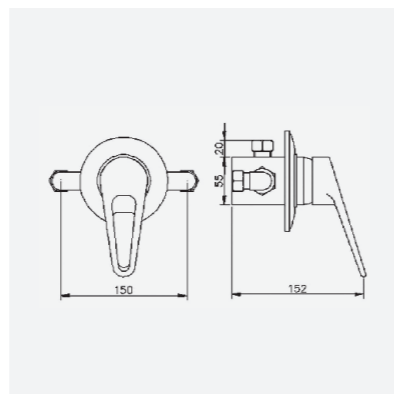

**Alpha Valve**

- 15mm Manual valve including single function fixed head
- Also suitable for concealed installation

CODE ALAVAL



**Concealed Non Concussive Shower Valve and Fixed Shower Head**

- Height: 1292mm
- Valve not included

CODE VM21Q

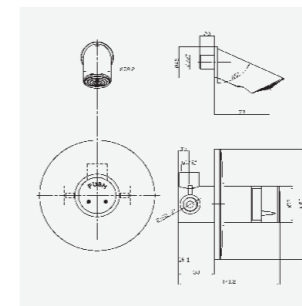

**Concealed Non Concussive Shower Valve and Fixed Shower Head**

- CE Approved
- Adjustable flow rate
- Temperature adjustment
- Flow Rate at 1Bar: 6.6ltr/min
- Minimum Operating Pressure - 1 Bar

CODE AVUT42

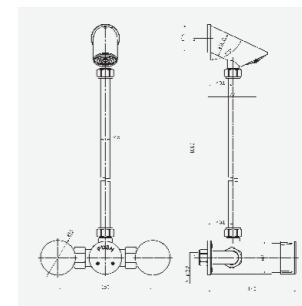
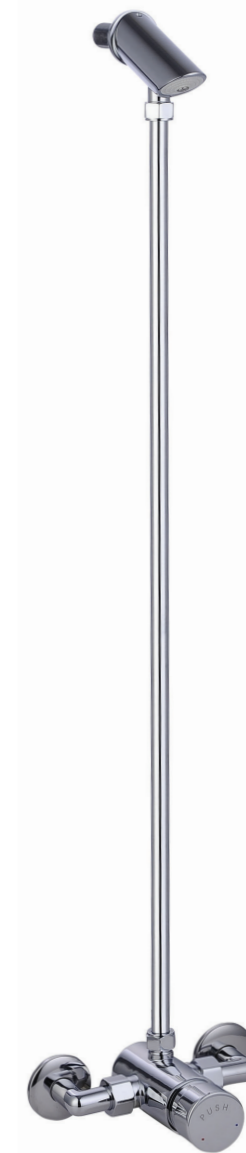

**Exposed Non Concussive Shower Valve and Fixed Shower Head**

- CE Approved
- Adjustable flow rate
- Temperature adjustment
- Flow Rate at 1Bar: 6.6ltr/min
- Minimum Operating Pressure - 1 Bar

CODE AVUT41



**Wall Mounted Round Shower Arm**

L: 300mm

CODE AVSA01



**Wall Mounted Square Shower Arm**

L: 300mm / W: 35mm

CODE AVSA02



**Ceiling Mounted Round Shower Arm**

L: 300mm

CODE AVSA07



**Ceiling Mounted Square Shower Arm**

L: 300mm

CODE AVSA08



**Square Fixed Shower Head**

CODE AVSHP25



**Standard Round Fixed Shower Head**

CODE AVSHP27



**Round Shower Outlet**

CODE AVWE01



**Square Shower Outlet**

CODE AVWE22



**Metre Slide Rail Kit**

L: 1000mm

CODE RTLSR1M



**Luxury Brass Slide Rail Kit**

L: 700mm

CODE SR02



**Rectangular Slide Rail Kit**

L: 700mm

CODE AVSR01



**Round Slide Rail Kit**

L: 820mm

CODE USTY042



**Standard Slide Rail Kit**

L: 650mm

CODE AVSR41

# SHOWERING ACCESSORIES



**Premier Shower Curtain Rod**

An understated & elegant shower curtain rod with classic round wall brackets. Made from a combination of solid brass and aluminium. Maximum length 2m.

CODE FINISH

CROGP89500 Chrome

**Luxury Curved Rod**

A curved rod which holds the shower curtain away from the user, increasing space and eliminating cling. The 90° return ensures that water is contained in the bath. Can be fitted within opposite walls for a straight run or on adjacent walls for an L-shape configuration. Maximum length 2m.

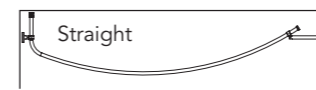

Straight



L Shape

CODE FINISH

CROAD108341 Chrome



**Heavy Duty Telescopic Rod**

Secure, self supporting rod manufactured from ultra strong fluted aluminium. The rod is spring loaded for quick and easy fitting and removal.

CODE DIMENSIONS FINISH

CROGP89000 110 - 195mm Silver

**Slenderline**

A strong yet lightweight aluminium rail system. Comes complete with ceiling support, hooks and gliders. Can be used to create any one of four assembly options. Use standard size or trim to your exact requirements. Strong, durable and easy to install, all fixings are included.



4 Way	L-shape	Large L-shape	Large U-shape	Straight
	910 x 910mm	910 x 1675mm	910 x 676mm	1800mm

CODE FINISH

CROGP87000 Silver

**Bendy Rail**

Two separate aluminium extrusions sandwich a malleable PVC core which allows the rail to be bent at any point to suit the shape of any bath or shower tray. Use as standard size or trim to your exact requirements. Strong, durable and easy to install, all fixings are included.



CODE DIMENSIONS FINISH

CROGP78100 2500mm Silver



**L-Shaped** - Includes ceiling support

CODE DIMENSIONS FINISH

CROGP85600 91.5 x 91.5cm Silver

CROGP85700 76 x 167.5cm Silver

**Hook and Glider Pack**

Suitable for use with both 400 & 800 rails where more than 1 shower curtain is required. Includes 12 hook and gliders.



CODE FINISH

CROGP98900 White

**Shower Curtain Rings - Button Clear**

Suitable for use with shower curtain rods up to 33mm in diameter. Supplied in sets of 12 to use with one standard shower curtain.



CODE

CROAK142232

**Ceiling Support Silver - 91.5cm**

CODE CROGP98700



**Chrome Ball Curtain Ring**

- Suitable for use with shower curtain rods up to 29mm in diameter  
- Supplied in sets of 12 to use with one standard shower curtain



CODE AK141641

**High Performance Textile Shower Curtain**

- Pro Seal coating  
- Easy Clean machine washable  
- Extra Heavy cling-resistant weighted hem



**180 x 180cm**

CODE CROGP00801

**200 x 180cm**

CODE CROGP85115

**Hygiene "N" Clean Plain Textile Shower Curtain**

- Pro seal coating  
- Easy clean machine washable  
- Treated with Hygiene "N" clean anti-microbial additive  
- Extra Heavy cling-resistant weighted hem



CODE AF286822H



**Bath Screen Seal Kit 8-18mm**

CODE FINISH

CROAM160432 Clear

# BATHS

GRANADA TWIN GRIP - Includes grips, tap holes & anti-slip.



**Granada**  
1700 x 700 x 345mm  
(5mm thickness)

CODE GRAN1700TG5MM

**Granada**  
1700 x 700 x 345mm  
(8mm thickness)

CODE GRAN1700TG8MM

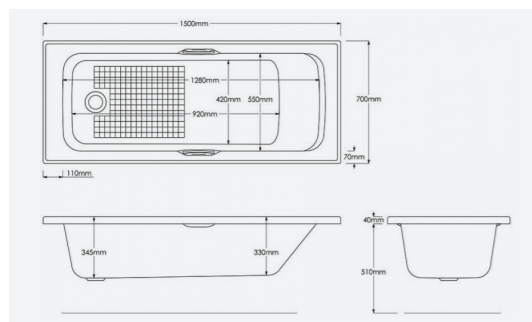

**Granada**  
1500 x 700mm  
(5mm thickness)

CODE GRAN1500TG5MM

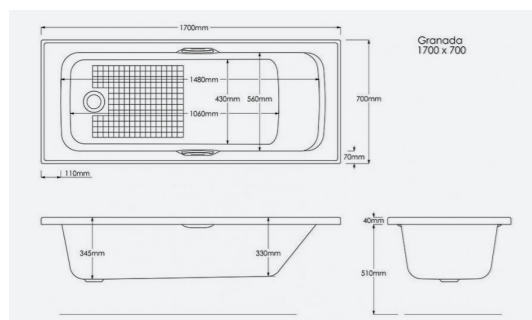

Note: All Granada baths are drilled for tap holes.

## CLINTON



Note:  
Waste not  
included.

**Clinton SE - White**  
L: 1500mm  
W: 700mm H: 400mm

Code BCLIN15X70

**Clinton SE - White**  
L: 1600mm  
W: 700mm H: 400mm

Code BCLIN16X70

**Clinton SE - White**  
L: 1700mm  
W: 700mm H: 400mm

Code BCLIN17X70

**Clinton SE - White**  
L: 1700mm  
W: 700mm H: 400mm

Code BCLIN17X70STONE

**Clinton SE - White**  
L: 1700mm  
W: 750mm H: 400mm

Code BCLIN17X75

**Clinton SE - White**  
L: 1800mm  
W: 800mm H: 400mm

Code BCLIN18X80



Clinton Stone Baths offer increased rigidity, strength and therefore greater thermal qualities.

# STEEL BATHS



## 1500mm Plain Steel Bath

L: 1500mm W: 700mm  
H: 390mm

- Drilled for tap holes
- Not drilled for Grip holes
- No anti-slip

CODE BB1500-2TH

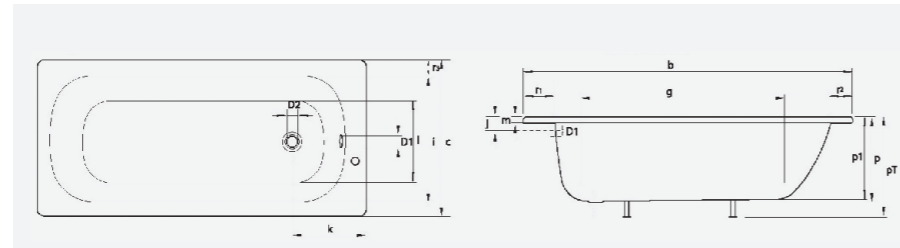

## 1700mm Plain Steel Bath

L: 1700mm W: 700mm  
H: 390mm

- Drilled for tap holes
- Not drilled for Grip holes
- No anti-slip

CODE BB1700-2TH

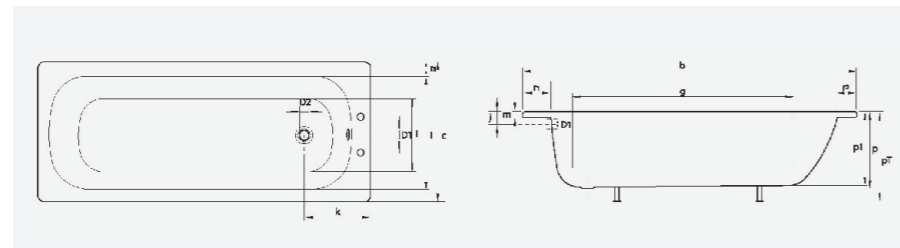

## 1700mm Steel Bath with Antislip - No Tap Hole

L: 1700mm W: 700mm  
H: 390mm

- Not drilled for tap holes
- Drilled for grip holes
- With anti-slip

CODE BB1700TG-NTH

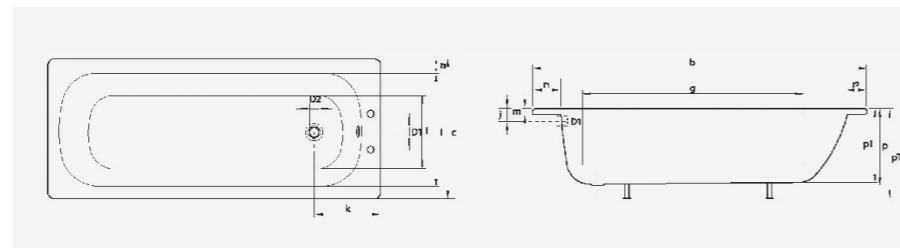

## 1700mm Steel Bath with Antislip

L: 1700mm W: 700mm  
H: 390mm

- Drilled for tap holes
- Drilled for grip holes
- With anti-slip

CODE BB1700TG-2THA

## Twin Grips for Steel Bath

CODE KALGRIPS

# LESS ABLED BATHS



## Bathe Easy P Shape Concert Walk in Shower bath 1675 x 850 x 750mm

The Concept P Shower bath is spacious and with a contemporary design to suit any bathroom and is suitable for all the family. Supplied with LH and RH Door entry option.

- LH or RH handed by glass door
- The bath is manufactured in glass fibre with a gel - coat surface
- Slip resistant base for added piece of mind
- 10mm thick toughened glass door with anti-stain coating - positioned at opposite end to the shower area
- 6mm thick toughened glass shower screen, 1400mm high, chrome profile and towel rail
- Simple to operate manual locking system with a push and pull mechanism (20 Newton's/ 4.5lbs of pressure) Not electric just an effective manual system
- Grade 304 Polished Stainless steel Alloy - handles, lock & hinges
- The bath is supplied with Twin McAlpine clicker spring wastes for 40% quicker drainage and security
- Supplied with: Shower Screen, Twin Wastes, Front and End Panel
- Water Capacity - 1675x850x750mm Unoccupied = 225 litres
- 10 Year Guarantee

Left Hand CODE E0011

Right Hand CODE E0012

## Bathe Easy Comfort Easy Access 1210 x 650mm

The Comfort is a deep soak bath with an integral seat. Designed to maximise internal space and with a modern contemporary appearance. Supplied with LH and RH door entry option.

- LH or RH handed by glass door
- 10mm thick toughened glass door with anti-stain coating
- Low threshold door
- Comfortable integral moulded seat
- Seat height of 395mm
- The bath is manufactured in glass fibre with a gel - coat surface
- Slip resistant base for added piece of mind
- Simple to operate manual locking system with a push and pull cam lever (20 Newtons/ 4.5lbs of pressure) Not electric just an effective manual system
- Grade 304 Polished Stainless steel Alloy - handles, lock & hinges
- The bath is supplied with Twin McAlpine clicker spring wastes for 40% quicker drainage and security
- Supplied with: Twin Wastes, Front and End Panel
- Water Capacity - 1210 x 650mm Unoccupied = 225 litres
- 10 Year Guarantee

Left Hand CODE E0019

Right Hand CODE E0020

# BATH PANELS

## SUPERSTYLE BATH PANELS

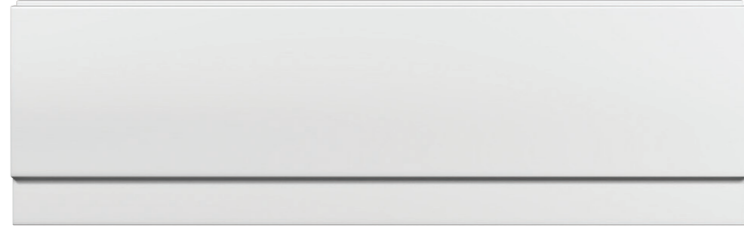

DESCRIPTION	CODE
750 x 510mm (2mm thickness)	PLA750
800 x 510mm (3mm thickness)	PLA800
1700 x 510mm (2mm thickness)	PLA1700
1800 x 510mm (3mm thickness)	PLA1800

## HI-GLOSS TIMBER BATH PANELS



DESCRIPTION	CODE
High Gloss White 700mm - 2 Piece	HG700
High Gloss White 750mm - 2 Piece	HG750
High Gloss White 800mm - 2 Piece	HG800
High Gloss White 900mm - 2 Piece	HG900

DESCRIPTION	CODE
High Gloss White 1700mm - 2 Piece	HG1700
High Gloss White 1800mm - 2 Piece	HG1800
High Gloss White 1900mm - 2 Piece	HG1900
Height of panel 442mm - 570mm	

## HEAVY DUTY ACRYLIC BATH PANELS

DESCRIPTION	CODE
Heavy Duty 700 x 565mm	BPANEL700
Heavy Duty 800 x 565mm	BPANEL800
Heavy Duty 900 x 565mm	BPANEL900

DESCRIPTION	CODE
Heavy Duty 1700 x 565mm	BPANEL1700
Heavy Duty 1800 x 565mm	BPANEL1800
Heavy Duty 1900 x 565mm	BPANEL1900

# BRASSWARE

## ALPHA

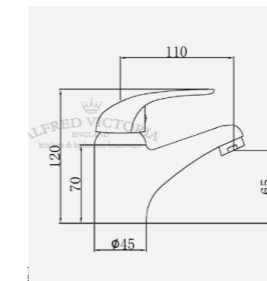

### Alpha Basin Mono Low Pressure Tap

- Minimum operating pressure 0.2 bar
- Includes push-button waste

CODE UALA305

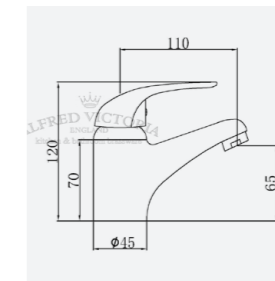

### Alpha Eco Basin Mono Low Pressure Tap

- Minimum operating pressure 0.2 bar
- Includes push-button waste

CODE UALA315

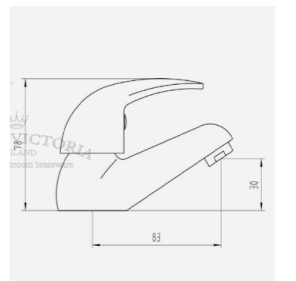

### Alpha Basin Taps

- Minimum operating pressure 0.1 bar

CODE UALA301

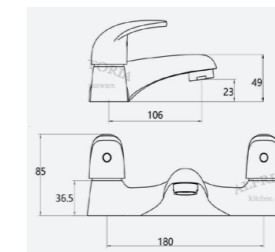

### Alpha Bath Mixer

- Minimum operating pressure 0.1 bar

CODE UALA333

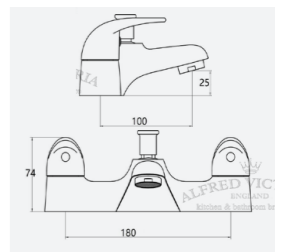

### Alpha Bath Shower Mixer

- Minimum operating pressure 0.1 bar

CODE UALA334

# BRASSWARE

## EIRLINE

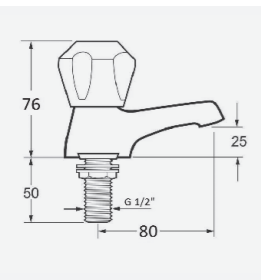

**Eirline  
Basin Taps**

CODE 580001

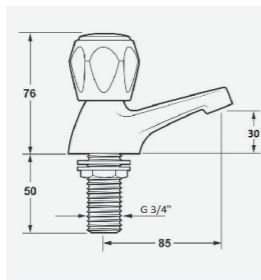

**Eirline  
Bath Taps**

CODE 580002

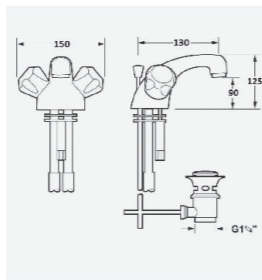

**Eirline  
Mono Basin Mixer**

CODE 580007

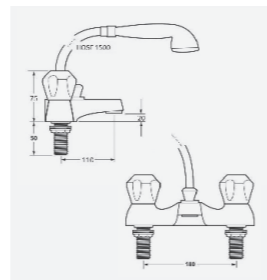

**Eirline  
Bath Shower Mixer**

CODE 580005

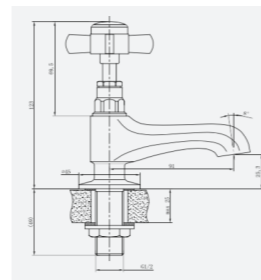

**Traditional  
Basin Taps**

CODE UTRD001

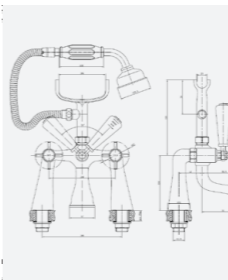

**Traditional  
Bath Shower Mixer**

CODE UTRD003

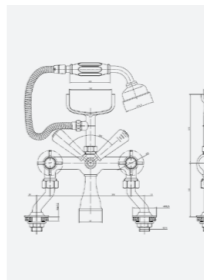

**Traditional Cranked  
Bath Shower Mixer**

CODE UTRD009

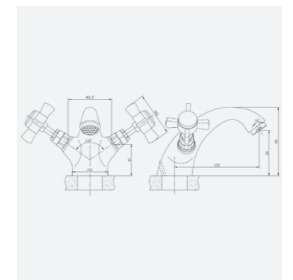

**Traditional  
Mono Basin Mixer**

CODE UTRD005

## VICTORIAN

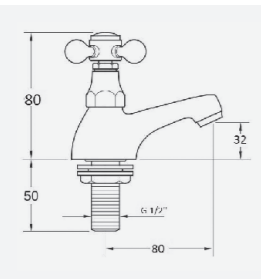

**Victorian  
Basin Taps**

CODE UV001

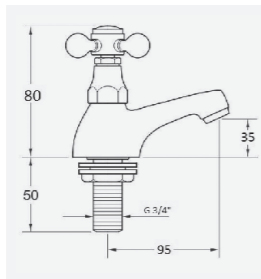

**Victorian  
Bath Taps**

CODE UV002

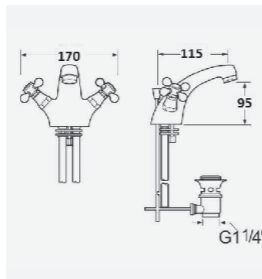

**Victorian  
Mono Basin Mixer**

CODE UV005

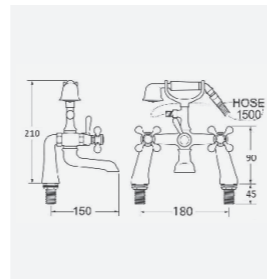

**Victorian  
Bath Shower Mixer**

CODE UV004

### Traditional Brassware Pack

- Consists of; Basin Taps, Basin Waste, Bath Shower Mixer, Bath Waste

CODE UTRD010

## PORTA & BINI

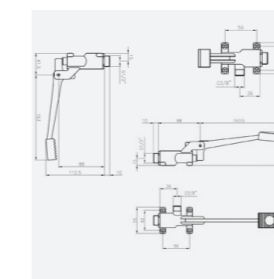

**Pedal Operated  
Mixer for Floor**

CODE PB460

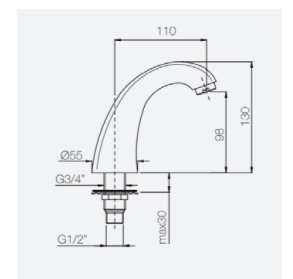

**Basin  
Spout**

CODE PB370



# BRASSWARE

## COMMERCIAL

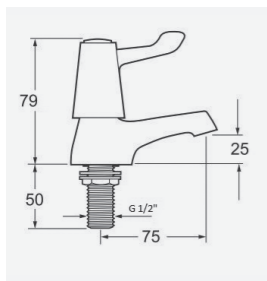

**Commercial Basin Taps**

CODE URTCG301

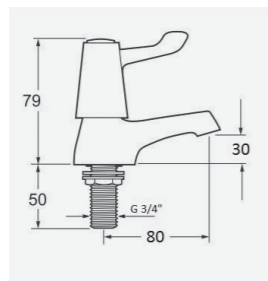

**Commercial Bath Taps**

CODE URTCG302

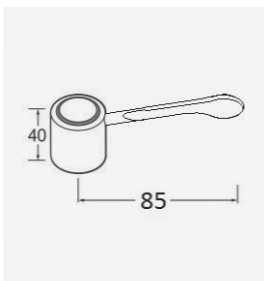
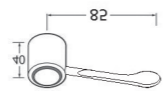

**Commercial 3" Lever Kit**

CODE URTCG300

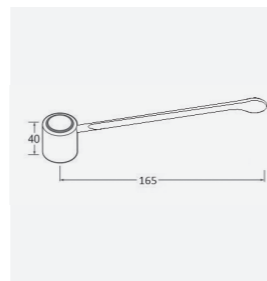

**Commercial 6" Lever Kit**

CODE URTCG311

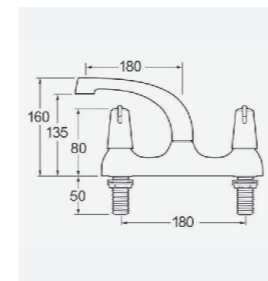

**Commercial Deck Sink Mixer**

CODE URTCG303

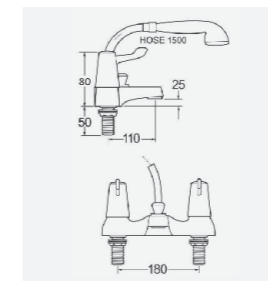

**Commercial Bath Shower Mixer**

CODE URTCG304

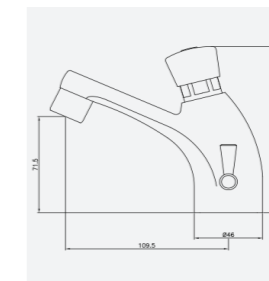

**Non Concussive Mono Basin Mixer**

CODE UCG491

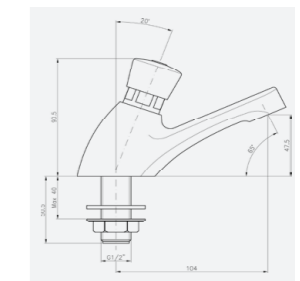

**Non Concussive Mono Basin Taps (Pair)**

CODE UCG468

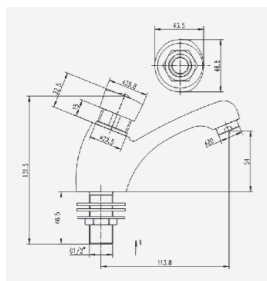

**Standard Non Concussive Taps**

CODE URTCG320

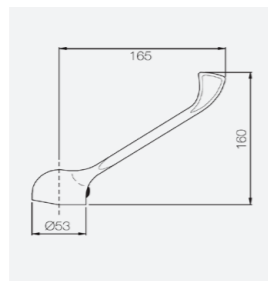

**Alpha 9" Lever Mono**

CODE UALA305EXT

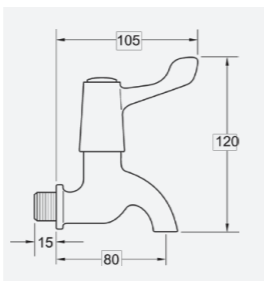

**3" Lever Bib Taps (Pair)**

CODE SHA701L

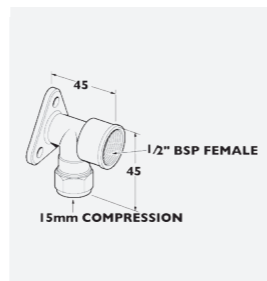

**Back Plate (Pair)**

CODE SHABRA

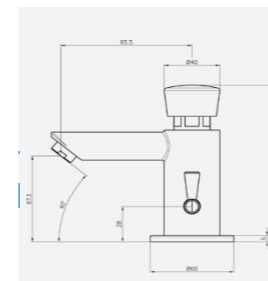

**Modern Non Concussive Mono Basin Mixer**

CODE UCG467

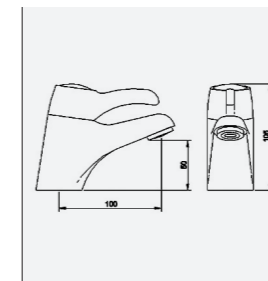

**Solo Spray Mixer**

CODE UCD311

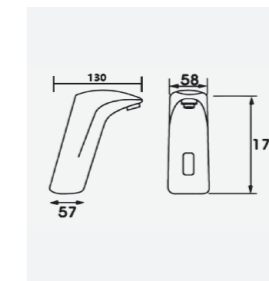

**RT03 Sensor Tap**

CODE AVRT03

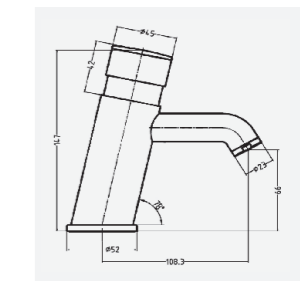

**Non Concussive Basin Mixer**

CODE AVUT05

# BRASSWARE

# VICTORY VALVES

## THERMOSTATIC RANGE

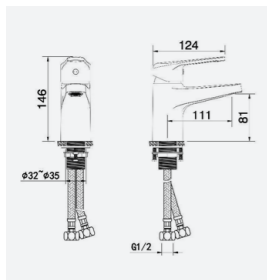

**Basin Mono Mixer**

CODE AVBH05

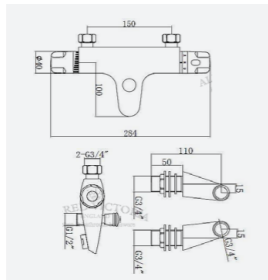

**Solo Thermostatic Bath Shower Mixer**

CODE TVM40B

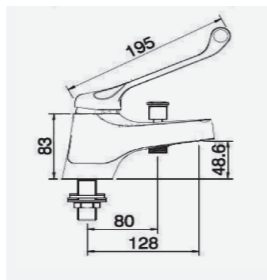

**Smart Lever Thermo Bath Mixer**

CODE AVBM04

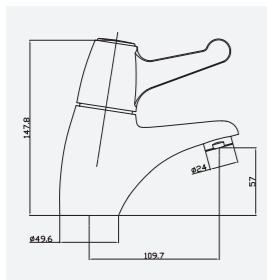

**Mono Basin Mixer**

CODE AVUT73

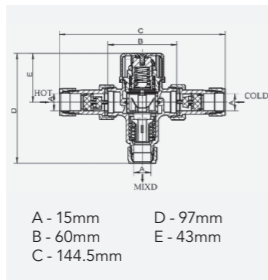

**TMV Valves 15mm**

CODE RCD363

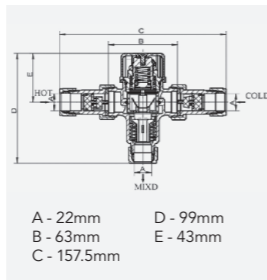

**TMV Valves 22mm**

CODE RCD362



**Exposed With No Back Plate**

CODE VIC51S  
(Push Button as illustrated)



**Exposed With Back Plate**

CODE VIC52  
(Lever as illustrated)

CODE VIC53  
(Similar to above but with Press Button)

CODE VIC54  
(Similar to VIC52 but with Opp. Hand)

CODE VIC55  
(Similar to VIC53 but with Opp. Hand)



Note: Left hand water inlet shown

**Concealed**

CODE VIC72  
(as illustrated)

CODE VIC70  
(Similar to above but with Opp. Hand)

CODE VIC71  
(Similar to VIC70 but with Lever)

CODE VIC73  
(Similar to VIC71 but with Opp. Hand)

NO	DESCRIPTION
N7X (7)	SPINDLE SPRING
N6X (6X)	SPINDLE
NUT (20)	EXTENSION BACK NUT
N30 (21)	EXTENSION BACK PLATE
VIC4INCH (22)	EXTENSION PUSH ROD
VIC6INCH (23)	EXTENSION TUBE
N24 (24)	EXTENSION FRONT PLATE
VIC9INCH (25)	EXTENSION FRONT CAP
COL (13X)	PUSH BUTTON
N15 (15)	GLAND O RING

### Extension Pieces

Extension Pieces include cover plates

#### 4.5" Extension Piece

CODE VIC4INCH

#### 6" Extension Piece

CODE VIC6INCH

#### 9" Extension Piece

CODE VIC9INCH

# BASIN WASTES



**Push Button Basin Waste**

Slotted

CODE UREK303

Unslotted

CODE UREK304



**Flip Top Basin Waste**

Slotted

CODE UER03

Unslotted

CODE UER02



**Basin Waste**

With brass plug and ball chain

CODE URE303



**EasyClean Sprung Plug Basin Waste**

Slotted

CODE URE328



**Free Running Basin Waste**

Unslotted

CODE UREK305

# OTHER WASTES



**Bath Filler With Sprung Waste**

Length: 850mm  
Blending valve required

CODE UWA89

**NOTE** - To be used with sequential valve



**Roll Top Bath Pack**

CODE UEA368



**Freeflow Bath Filler**

Length: 500mm  
No blending valve required

CODE UE301

# BATH WASTES



**Bath Waste & Overflow**

- With brass plug and ball chain
- Suitable for baths up to 5mm thick

CODE UE396



**Retainer Bath Waste & Overflow**

- With brass plug and ball chain
- Suitable for baths up to 20mm thick

CODE URE347



**Economy Bath Pop-Up Waste & Overflow**

- Suitable for baths up to 20mm thick

CODE UEA318



**Extended Bath Pop-Up Waste & Overflow**

- Suitable for baths up to 10mm thick

CODE UEA333



**EasyClean Sprung Plug Bath Waste**

- With minimalist overflow
- Suitable for baths up to 13mm thick

CODE UE327

# BOTTLE TRAPS



**Basin Bottle Trap**

CODE UEA370



**Minimalist Bottle Trap**

CODE UREK302



**Square Bottle Trap**

CODE UEK306

## SANIFLO UP



The original macerator pump unit that allows installation of an extra WC almost anywhere when a conventional solution isn't possible. SANIALARM may be fitted with this unit.

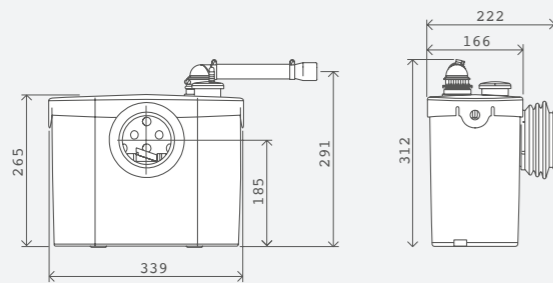

### PRODUCT INFORMATION

**Discharge Pipework**  
22 / 28 / 32mm

**Working Waste Water Temperature** – 35°C

**Motor Power**  
400 Watts

**Pumping Height**  
5 Metres

**Voltages**  
220-240 V/50 Hz

**IP Rating**  
IP44

CODE SANIFLO

## SANITOP UP



Similar to the original Saniflo Up but allows connection of a WC and a wash basin to one macerator pump. A great choice for a small cloakroom. SANIALARM may be fitted with this unit.

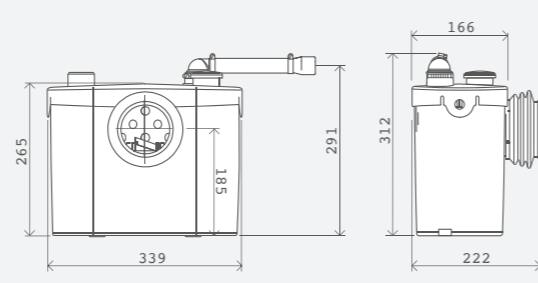

### PRODUCT INFORMATION

**Discharge Pipework**  
22 / 28 / 32mm

**Pumping Height**  
5 Metres

**Motor Power**  
400 Watts

**Inlet Pipework**  
40mm

**Voltages**  
220-240 V/50 Hz

**IP Rating**  
IP44

**Working Waste Water Temperature** – 35°C

CODE SANITOP

## SANIPLUS UP



The Saniplus Up enables you to install an additional bathroom with ease. With two inlets and a greater tank capacity, the Saniplus Up can easily deal with a WC, wash basin, bidet and even the highest output power showers. SANIALARM may be fitted with this unit.

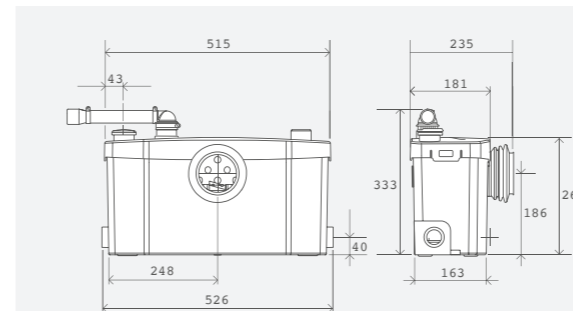

### PRODUCT INFORMATION

**Discharge Pipework**  
22 / 28 / 32mm

**Pumping Height**  
5 Metres

**Motor Power**  
400 Watts

**Inlet Pipework**  
40mm

**Voltages**  
220-240 V/50 Hz

**IP Rating**  
IP44

**Working Waste Water Temperature** – 35°C

CODE SANIPLU

## SANISLIM



When you need slimline sanitaryware you need a macerator pump to match. Sanislim needs just 145mm depth behind the WC and, with an inlet either side, it can take waste from a WC, a shower, wash basin and bidet if required. SANIALARM may be fitted with this unit.

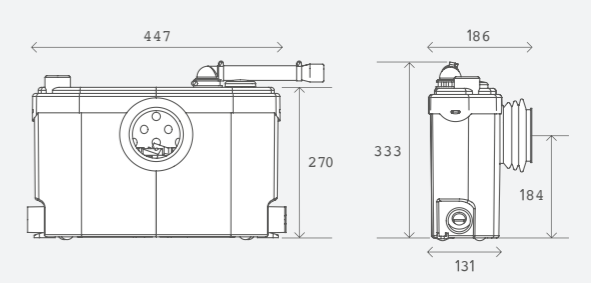

### PRODUCT INFORMATION

**Discharge Pipework**  
22mm

**Pumping Height**  
2.5 Metres

**Motor Power**  
400 Watts

**Inlet Pipework**  
40mm

**Voltages**  
220-240 V/50 Hz

**IP Rating**  
IP44

**Working Waste Water Temperature** – 35°C

CODE SANISLIM

### SANIPACK PRO UP



Designed to be concealed from view, where back-to-wall or wall-hung sanitaryware is required, the extra slim Sanipack Pro Up can take waste from a WC, wash basin and shower. An ideal choice for a modern, sleek finish. SANIALARM may be fitted with this unit.

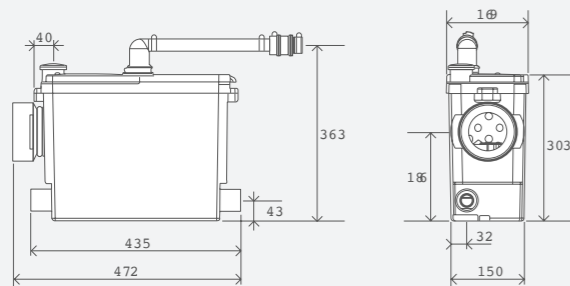

#### PRODUCT INFORMATION

<b>Discharge Pipework</b> 22 / 28 / 32mm	<b>Pumping Height</b> 5 Metres
<b>Motor Power</b> 400 Watts	<b>Inlet Pipework</b> 40mm
<b>Voltages</b> 220-240 V/50 Hz	<b>IP Rating</b> IP44
<b>Working Waste Water Temperature</b> – 35°C	<b>CODE</b> SANIPAC

### SANIPRO UP



The Sanipro Up is ideal for adding an en-suite. With two inlets the Sanipro Up can easily deal with a WC, wash basin, bidet and a power shower. SANIALARM may be fitted with this unit.

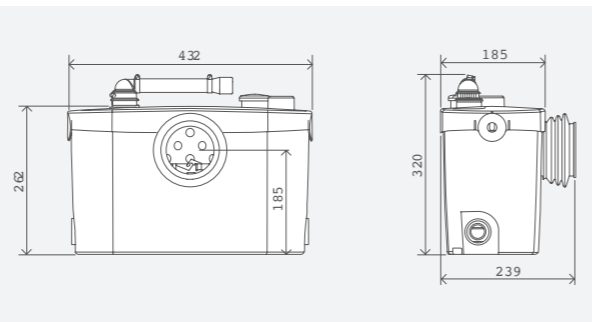

#### PRODUCT INFORMATION

<b>Discharge Pipework</b> 22 / 28 / 32mm	<b>Pumping Height</b> 5 Metres
<b>Motor Power</b> 400 Watts	<b>Inlet Pipework</b> 40mm
<b>Voltages</b> 220-240 V/50 Hz	<b>IP Rating</b> IP44
<b>Working Waste Water Temperature</b> – 35°C	<b>CODE</b> SANIPRO

### SANICOMPACT



A super-compact WC unit with a built in macerator that's perfect for small cloakrooms. It even features a wash-basin inlet and needs no cistern to make the most of the smallest spaces.



#### PRODUCT INFORMATION

<b>Discharge Pipework</b> 32mm	<b>Pumping Height</b> 3 Metres
<b>Motor Power</b> 550 Watts	<b>Double Flush</b> 1.8 litre / 3 litres
<b>Voltages</b> 220-240 V/50 Hz	<b>IP Rating</b> IP44
<b>Working Waste Water Temperature</b> – 35°C	<b>CODE</b> SANICOMPACT

### SANIVITE+



Ideally suited to a kitchen or utility room, Sanivite+'s powerful pump has four inlets for connection to domestic sinks or appliances. With compact dimensions, Sanivite + can be concealed in a kitchen unit or behind a demountable panel to give access for servicing. SANIALARM may be fitted with this unit.

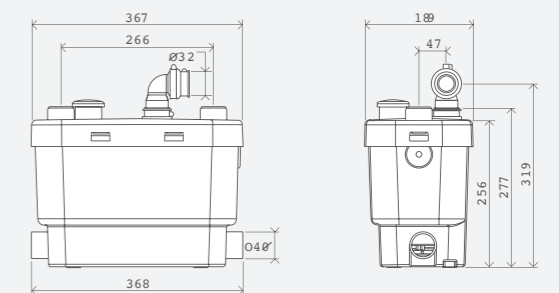

#### PRODUCT INFORMATION

<b>Discharge Pipework</b> 32mm	<b>Pumping Height</b> 6 Metres
<b>Motor Power</b> 400 Watts	<b>Inlet Pipework</b> 40mm
<b>Voltages</b> 220-240 V/50 Hz	<b>IP Rating</b> IP44
<b>Working Waste Water Temp</b> – 35°C max 60°C	<b>CODE</b> SANIVITE

### SANISHOWER+



The Sanishower + can be installed next to a shower tray with access for maintenance. Capable of pumping a standard electric or gravity mixer shower. Two inlets mean a wash basin can be added too. SANIALARM may be fitted with this unit.

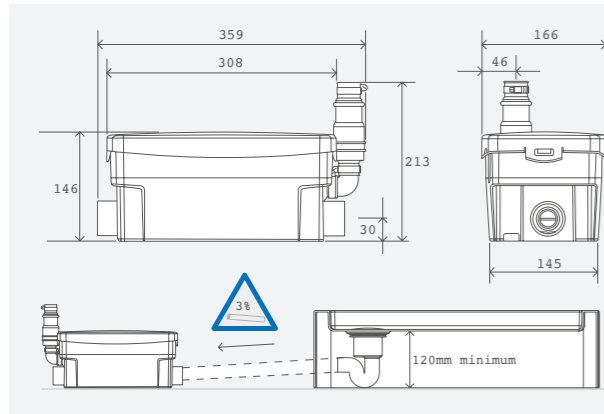

#### PRODUCT INFORMATION

<b>Discharge Pipework</b> 22 / 32mm	<b>Inlet Pipework</b> 40mm
<b>Motor Power</b> 400 Watts <b>Voltages</b> 220-240 V/50 Hz	<b>IP Rating</b> IP44
<b>Working Waste Water Temperature</b> - 35°C	<b>Activation Level</b> 65mm
<b>Pumping Height</b> 5 Metres	<b>CODE</b> SANISHO

### SANICONDENS ECO



The Sanicondens® Eco is specifically designed for disposal of acidic concentrate from boilers and other water producing equipment such as air conditioning units, refrigeration units and dehumidifiers etc.

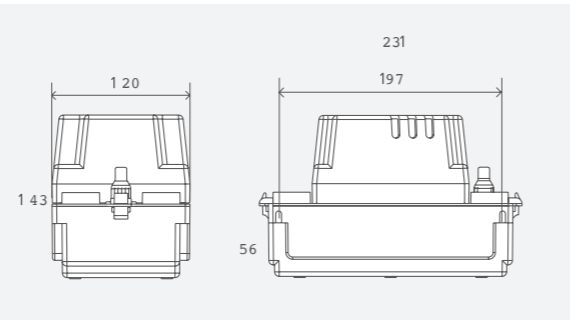

#### PRODUCT INFORMATION

<b>Discharge Pipework</b> 8 / 11mm	<b>Working Waste Water Temp</b> 35°C/Max 80°C (Intermittent)
<b>Motor Power</b> 600 Watts	<b>Pumping Height</b> 4.5 Metres
<b>Flow Rate</b> 342 L/h	<b>Inlet Pipework</b> 28mm
<b>Voltages</b> 220-240 V/50 Hz	<b>IP Rating</b> IP20
<b>Tank Volume</b> 1 Litre	<b>CODE</b> SANICOND

### SANIFLOOR

Designed specifically where floor drainage is required but where space underneath is very limited e.g. wet rooms. This two part kit with a powerful shower waste pump and a choice of three waste designs can pump up to 3m vertically as well as 30m horizontally. Higher flow rate means it can be used with powerful 'rain head' showers.

#### Vertical / Horizontal Performance

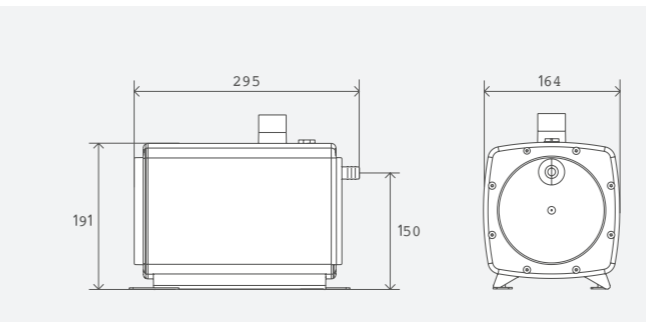

#### PRODUCT INFORMATION

<b>Discharge Pipework</b> 32mm	<b>Product Weight</b> 23.2kg
<b>Motor Power</b> 550 Watts	<b>Double Flush</b> 1.8 litre / 3 litres
<b>Voltages</b> 220-240 V/50 Hz	<b>IP Rating</b> IP44
<b>Working Waste Water Temperature</b> - 35°C	<b>CODE</b> SANIFLOOR1
	<b>CODE</b> SANIFLOOR2
	<b>CODE</b> SANIFLOOR3



#### Why choose this product?

- Suits wet rooms and low level shower trays
- Ideal for high flow applications
- Pump and waste inlet can be up to 3m apart horizontally
- Dual function - sucks waste up from the gully and pumps waste water away up to 3m vertically or 30m horizontally
- Pump can be sited up to 300mm above the gully
- All gully types are 90mm in diameter



#### Gully Types

1. SANIFLOOR1 - With shower waste for tiled floor - Height 68mm
2. SANIFLOOR2 - With shower waste for vinyl floor - Height 68mm
3. SANIFLOOR3 - With shower waste for trays - Height 63mm



# SANIFLO

## SANIALARM

The Sanialarm® has a level pressure switch that triggers an alarm fixed on the top of a unit if the volume of water exceeds the maximum allowed level. The alarm emits a continuous warning sound, until it is switched off and the problem rectified.

### Why choose this product?

- Helps protect against flooding
- 80dB buzzer
- Added peace of mind
- Easy and quick installation onto lid of Saniflo unit
- Suitable for new and existing Saniflo installations
- Fits most Saniflo products

### Power

2 x AAA batteries - 1.5v (Not included)

### Weight

0.17kg

CODE SANIALARM



## SANIFLO CLEANSER / DESCALER

Specifically created for use with Saniflo® units, the cleanser is a concentrated solution for optimum cleaning power and trouble-free maintenance.

### Why choose this product?

- Ideally suited to Saniflo units
- Won't damage septic tanks
- Comes in a 5 litre bottle for multiple applications
- Prolongs unit life and efficiency
- Use more frequently in hard water zones

### Weight

5.8kg per 5L bottle

CODE SANICLEAN

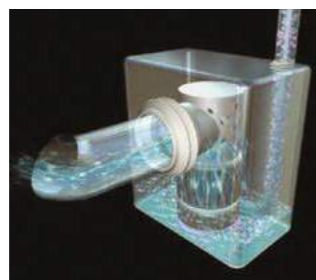

# UNDERGROUND PUMP STATIONS



### Allows a pumping station to be sited:

- Below ground
- External to a building
- Where the drainage is too low for the sewer
- Where the drainage is too low for a surface mounted pumping station

## SANIFOS 250 SANIFOS 500

- Sanifos range has both one and two pump products
- Single and three phase versions
- Powerful automatic motors with quiet operation
- Easy handling for installation below ground level

CODE SANIFOS250

CODE SANIFOS500

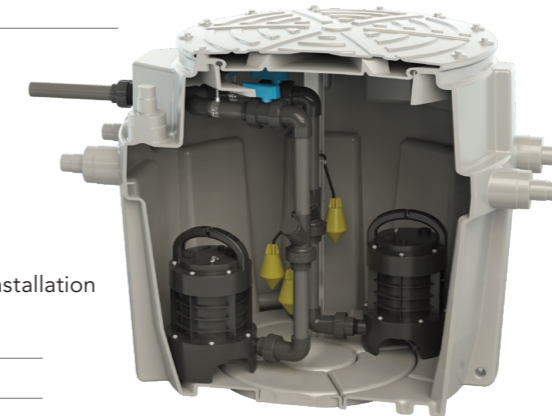

## SANIFOS 110

- Sanifos range has both one and two pump products
- Single and three phase versions
- Powerful automatic motors with quiet operation
- Easy handling for installation below ground level

CODE SANIFOS110



## SANIPUMP

- Waste water pump with cutting system
- Externally fitted float switch
- Quiet operation

CODE SANIPUMP

## SANISPEED+



Ideal for light commercial environments such as small shops, cafés, offices, bars and dental surgeries where grey waste water needs to be disposed of. Sanispeed® + deals with grey water from a shower, basin, bath, bidet, washing machine, dishwasher and sink. SANIALARM may be fitted with this unit.

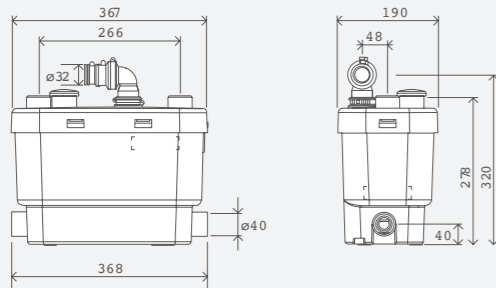

### PRODUCT INFORMATION

<b>Discharge Pipework</b> 32mm	<b>Pumping Height</b> 7 Metres
<b>Motor Power</b> 400 Watts	<b>Inlet Pipework</b> 40mm
<b>Voltages</b> 220-240 V/50 Hz	<b>IP Rating</b> IP44
<b>Working Waste Water Temp</b> 35°C/Max 75°C (Intermittent)	

CODE SANISPEED

## SANIBEST PRO



Sanibest Pro is a heavy duty macerator suitable for heavy usage public or commercial environments. Handles connection to a WC, basin, bidet and shower. SANIALARM may be fitted with this unit.

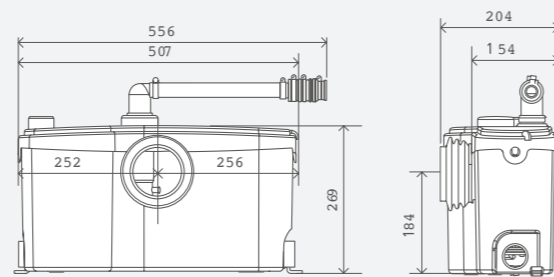

### PRODUCT INFORMATION

<b>Discharge Pipework</b> 32mm	<b>Pumping Height</b> 7 Metres
<b>Motor Power</b> 1100 Watts	<b>Inlet Pipework</b> 40mm
<b>Voltages</b> 220-240 V/50 Hz	<b>IP Rating</b> IP44
<b>Working Waste Water Temperature</b> – 35°C	

CODE SANIBESTPRO

## SANICOM 1



Sanicom 1 is an automatic, powerful lifting station for grey water used in busy commercial environments. Suitable for multiple connections including a basin, bath, shower, bidet, sink, dishwasher and washing machine.

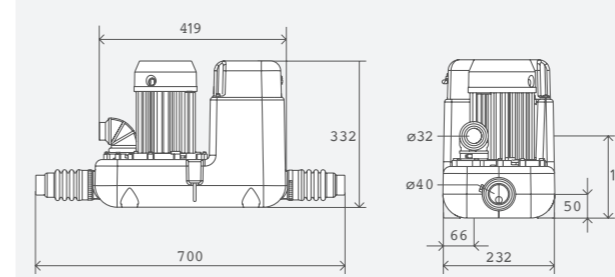

### PRODUCT INFORMATION

<b>Discharge Pipework</b> 32mm	<b>Working Waste Water Temp</b> 35°C/Max 90°C (Intermittent)
<b>Motor Power</b> 750 Watts	<b>Pumping Height</b> 8 Metres
<b>Voltages</b> 220-240 V/50 Hz	<b>Inlet Pipework</b> 40mm
<b>Tank Volume</b> 10L	<b>IP Rating</b> IP44

CODE SANICOM1

## SANICOM 2



Identical to Sanicom 1 but features two powerful motors where the second motor is a failsafe back-up to ensure that you always have continuity of service for your business.

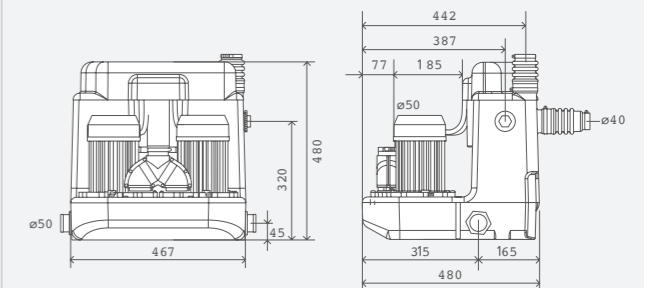

### PRODUCT INFORMATION

<b>Discharge Pipework</b> 50mm	<b>Working Waste Water Temp</b> 35°C/Max 90°C (Intermittent)
<b>Motor Power</b> 1500 Watts x2	<b>Pumping Height</b> 11 Metres
<b>Voltages</b> 220-240 V/50 Hz	<b>Inlet Pipework</b> 40 / 50mm
<b>Tank Volume</b> 34.5L	<b>IP Rating</b> IP44

CODE SANICOM2



# SANIFLO

## COMMERCIAL LIFTING STATIONS

### SANCUBIC 1

### SANCUBIC 2 PRO



The Sanicubic 1 is a robust macerator pump that has been designed for the discharge of waste from up to two WCs plus multiple grey water producing appliances in busy business environments and larger domestic situations.

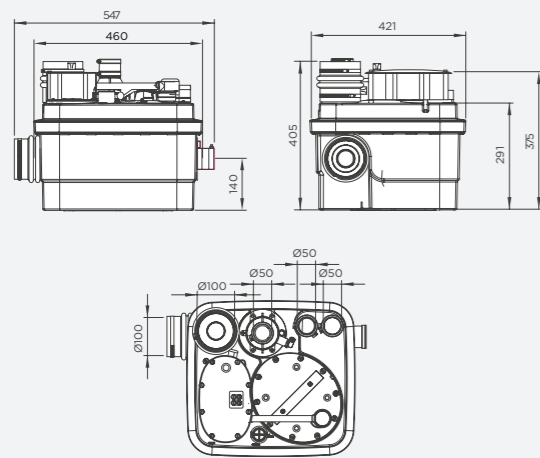

#### PRODUCT INFORMATION

<b>Discharge Pipework</b> 50mm	<b>Working Waste Water Temp</b> 35°C/Max 75°C (Intermittent)
<b>Motor Power</b> 1500 Watts	<b>Pumping Height</b> 11 Metres
<b>Flow Rate</b> 13m <sup>3</sup> /h	<b>Inlet Pipework</b> 40 / 50 / 100 / 110mm
<b>Voltages</b> 220-240 V/50 Hz	<b>IP Rating</b> IP67
<b>Tank Volume</b> 32L	<b>CODE</b> SANICUB1



The Sanicubic 2 Pro is a high performance macerating pump for commercial use. Contains two separate, load balanced pumps with high performance macerating systems and will operate alternately. In the event of inflow overload, both motors run at the same time, or in the unlikely event that one motor fails, the other one will take over.

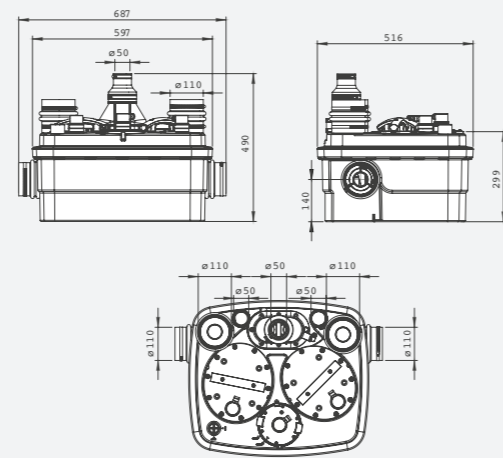

#### PRODUCT INFORMATION

<b>Discharge Pipework</b> 50mm	<b>Working Waste Water Temp</b> 35°C/Max 75°C (Intermittent)
<b>Motor Power</b> 1500 Watts x2	<b>Pumping Height</b> 11 Metres
<b>Flow Rate</b> 13m <sup>3</sup> /h	<b>Inlet Pipework</b> 40 / 50 / 100 / 110mm
<b>Voltages</b> 220-240 V/50 Hz	<b>IP Rating</b> IP68
<b>Tank Volume</b> 45L	<b>CODE</b> SANICUB2PRO

# GRUNDFOS PUMPS

## SHOWER PUMP BASICS

When selecting a shower pump, it is important to consider if the system is positive or negative head and what pressure is desired.

### Negative Head System

A negative head condition exists where the flow from the outlet is less than 0.5 litre/min. This is usually when there is insufficient pressure, under gravity, to provide a flow at the outlet.

### Positive Head System

A positive head condition exists where the flow from the outlet is more than 0.5 litre/min. This is usually when there is sufficient pressure, under gravity, to provide a flow at the outlet.

### Pump Pressure (measured in Bar)

In pump performance, 1.0 Bar is generally considered low pressure, 1.5-2.0 Bar medium pressure and ≥3.0 Bar high pressure, eg. to run multiple showers/heads.

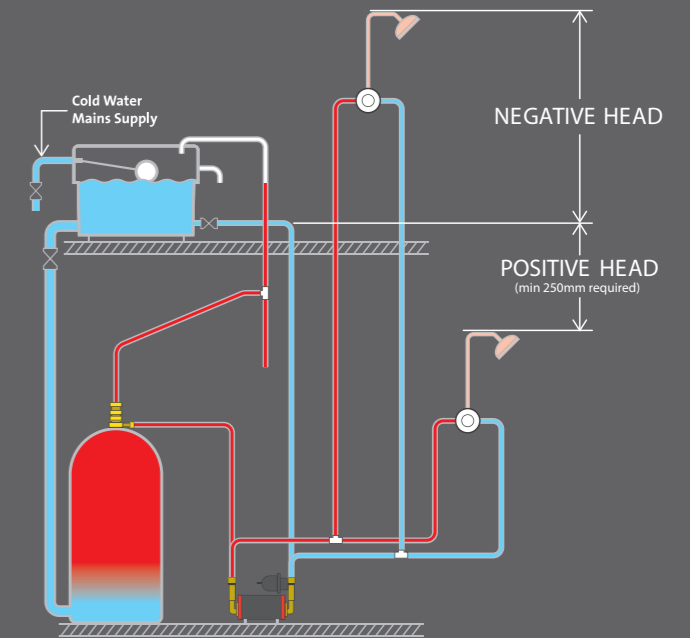

## SHOWER BOOSTER APPLICATION GUIDE

### Boost Gravity Hot/Cold

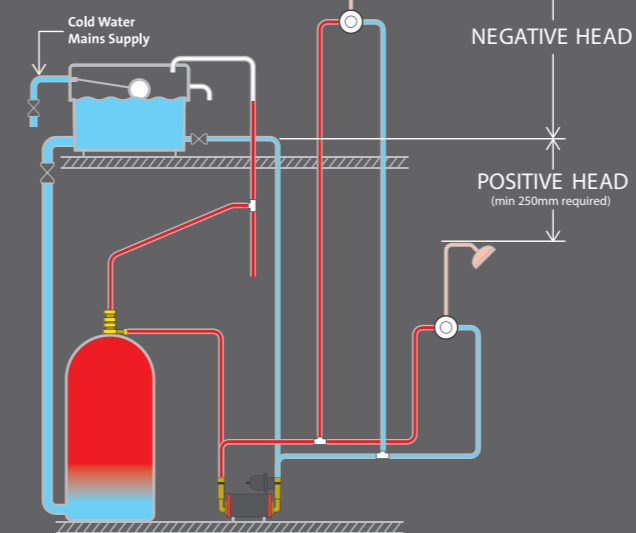

**Positive Head Pump Options:** STR2 Universal, STN, STR2 & STP  
**Negative Head Pump Options:** STR2 Universal & STN

# GRUNDFOS PUMPS

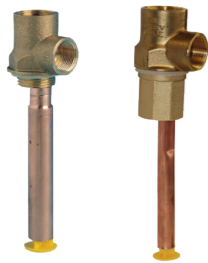

## SURREY

### WHAT IT DOES

Considered an industry standard, the Surrey flange is designed to provide an independent hot water supply as well as dramatically reduce air surging, noise and temperature variations. The Surrey flange air vent automatically purges the shower circuit, preventing air accumulation in the hot water shower feed (patent applied for). The vent automatically traps and releases air, preventing back feed of aerated hot water.

### TYPICAL APPLICATIONS

The installation of a Surrey flange is recommended for shower pumps up to 3 bar pressure.

### 15mm Surrey Flange:

To suit cylinder outlet of 1" BSP Female. Suited to pumps up to 1.5 bar pressure.

### 22mm Surrey Flange:

To suit Cylinder outlet of 1" BSP Female. Suited to pumps up to 3 bar pressure.

### PRODUCT CODES

Surrey Flange 15mm  
CODE GRUFLANGE15

Surrey Flange 22mm  
CODE GRUFLANGE22M



## STR2

### WHAT IT DOES

Positive head shower booster pump to increase water pressure to a gravity fed hot water system. Pumps available up to 2 Bar.

### TYPICAL APPLICATIONS

For boosting water to a single shower or simple bathroom suite where the outlets are below the cold water storage tank.

### FEATURES & BENEFITS

- Low noise design - quiet induction motor and minimal turbulence pump head
- Continuously rated
- Supplied with 22mm Stainless steel hoses
- Fitted with long-life seals
- WRAS Approved
- IPX2 water ingress protection
- Regenerative impeller designed to overcome air pockets

### PRODUCT CODES

Twin Impeller 1.5 bar  
CODE GRU98950232

Twin Impeller 2.0 bar  
CODE GRU98950233

### ACCESSORIES/SPARES

The installation of a Surrey Flange is recommended.



## STR2 Universal

### WHAT IT DOES

Positive & Negative head shower booster pump to increase water pressure to a gravity fed hot water system. Pumps available up to 2 Bar.

### TYPICAL APPLICATIONS

For boosting water to a single shower or simple bathroom suite where the outlets are above or below the cold water storage tank.

### FEATURES & BENEFITS

- Low noise design - quiet induction motor and minimal turbulence pump head
- Continuously rated
- Supplied with 22mm Stainless steel hoses
- Fitted with long-life seals
- WRAS Approved
- IPX2 water ingress protection
- Regenerative impeller designed to overcome air pockets
- Auto activation in Negative Head operation
- Dry run protection built in

### PRODUCT CODES

Twin Impeller 1.5 bar  
CODE GRU98950235

Twin Impeller 2.0 bar  
CODE GRU98950236

### ACCESSORIES/SPARES

The installation of a Surrey Flange is recommended.



## STP

### WHAT IT DOES

Positive head shower booster pump to increase water pressure to a gravity fed hot water system. Pumps available up to 4 Bar.

### TYPICAL APPLICATIONS

For boosting water to single/multiple showers or whole house boosting where the outlets are below the cold water tank.

### FEATURES & BENEFITS

- Low noise design - quiet induction motor and minimal turbulence pump head
- Continuously rated
- Supplied with 22mm Stainless steel hoses
- Fitted with long-life silicon carbide seals
- WRAS Approved
- IPX2 water ingress protection
- Regenerative impeller designed to overcome air pockets
- Premium brass pump head and impeller
- 5 year warranty (domestic use only)

### PRODUCT CODES

Twin Impeller 1.5 bar  
CODE GRU98284251

Twin Impeller 2.0 bar  
CODE GRU98284253

Twin Impeller 3.0 bar  
CODE GRU98284255

Twin Impeller 4.0 bar  
CODE GRU98284256

### ACCESSORIES/SPARES

The installation of a Surrey Flange is recommended for pumps up to 3 bar.



## STN

### WHAT IT DOES

Positive & Negative head shower booster pump to increase water pressure to a gravity fed hot water system. Pumps available up to 4 Bar.

### TYPICAL APPLICATIONS

For boosting water to single/multiple showers where the outlets are above or below the cold water tank.

### FEATURES & BENEFITS

- Low noise design - quiet induction motor and minimal turbulence pump head
- Continuously rated
- Supplied with 22mm Stainless steel hoses
- Fitted with long-life silicon carbide seals
- WRAS Approved
- IPX2 water ingress protection
- Regenerative impeller designed to overcome air pockets
- Premium brass pump head and impeller
- Auto activation in Negative Head operation
- Dry run protection built in
- 5 year warranty (domestic use only)

### PRODUCT CODES

Twin Impeller 1.5 bar  
CODE GRU98284257

Twin Impeller 2.0 bar  
CODE GRU98284259

Twin Impeller 3.0 bar  
CODE GRU98284261

Twin Impeller 4.0 bar  
CODE GRU98284262

### ACCESSORIES/SPARES

The installation of a Surrey Flange is recommended for pumps up to 3 bar.

# ARISTON

## Andris RS - Water Heater

- Quality steel tank, with exclusive titanium enamel coating
- Regulation & safety thermostat
- External temperature control
- Heating indicator light
- Simple installation
- Environmentally sound & highly efficient thermal insulation
- 2 year tank guarantee (1 year on electrical components)

- 6L Under Sink CODE AR6USRS
- 10L Under Sink CODE AR10USRS
- 15L Under Sink CODE AR15USRS
- 30L Over Sink CODE AR30OSRS



### DIMENSIONS & WATER TEMPERATURE RECOVER TIMES

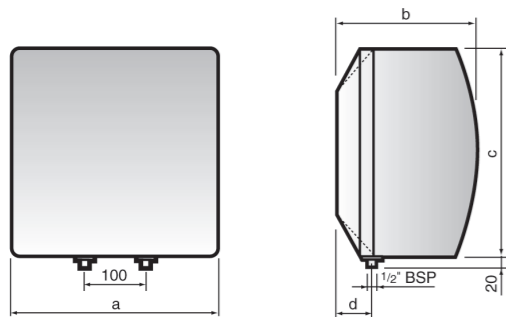

	A	B	C	D
6 LTR U/S	315mm	250mm	315mm	-
10 LTR U/S	350mm	255mm	350mm	90mm
15 LTR U/S	350mm	300mm	350mm	80mm
30 LTR O/S	440mm	365mm	440mm	110mm

#### Water Temperature Recovery Times

Size	Element	Time
6LTR	2KW	15mins
10LTR	2KW	17mins
15LTR	2KW	26mins
30LTR	2KW	52mins

#### ENERGY EFFICIENCY



## Andris Lux Eco

- Quality steel tank, with exclusive titanium enamel coating
- Regulation & safety thermostat
- External temperature control
- Eco function
- Simple LED Touch Screen
- 4 Year warranty



#### ELECTRIC TEMPERATURE MANAGEMENT

Providing precise temperature control and regulation, our new 'ECO' setting works to optimise comfort while saving energy.



#### ANTI-LEGIONELLA

The product's ABS safety package and antibacterial heating cycle work together to keep both your product and your water safe, for total peace of mind.



- 10 LTR U - 2.5kw CODE AR3100718
- 15 LTR U - 2.5kw CODE AR3100722

### DIMENSIONS

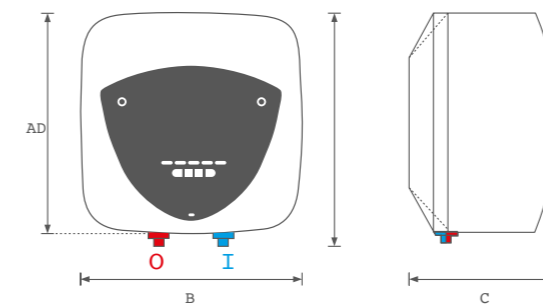

	A	B	C	D
10 LTR U - 2.5kw	360mm	360mm	294mm	385mm
15 LTR U - 2.5kw	360mm	360mm	342mm	385mm

#### ENERGY EFFICIENCY



# ARISTON

## Andris Installation Instructions

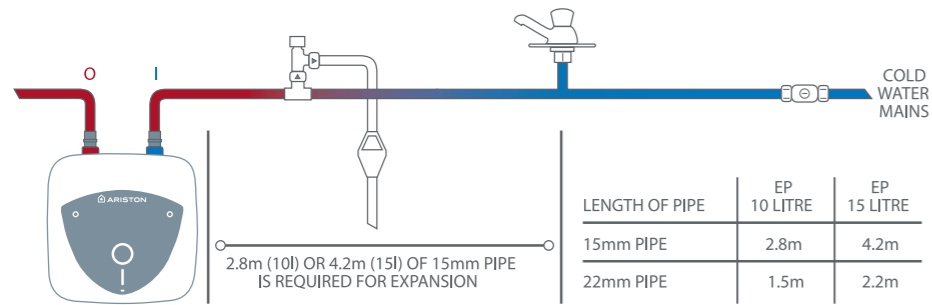

FIG 1.

- Carefully unpack the appliance and read the installation instructions.
- Make sure all the fitting components are present:
  - 6bar pressure relief valve.
  - Dielectric junctions (Connections for the appliance).
  - Wall hanging bracket.
- Fit dielectric junctions to inlet and outlet water connections.
- Mark the wall as outlined in the instruction booklet. Drill and affix the hanging bracket to the wall. Carefully hang the appliance on to the wall brackets.
- Turn off and isolate cold water supply. Tee into supply and, if required, fit pressure reducing valve and expansion vessel. Fit 6bar PRV and connect cold water supply to appliance inlet (see Fig. 2).

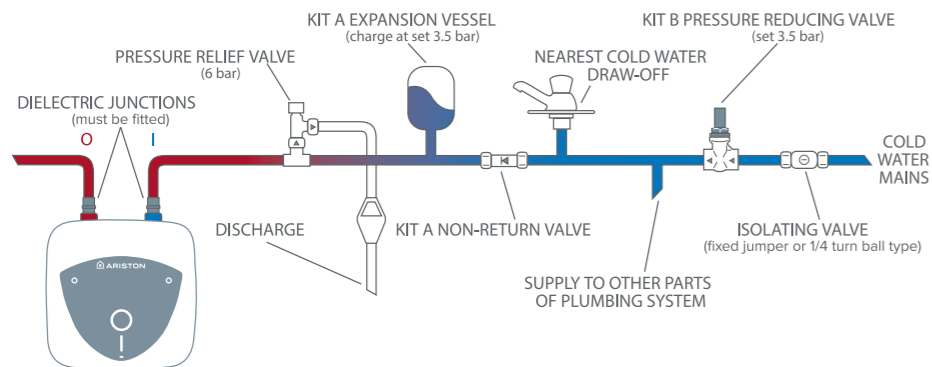

FIG 2. APPLICABLE TO 10L & 15L UNITS ONLY.

- Connect hot water outlet on appliance to the domestic hot water system.
- Install discharge pipe from the 6bar pressure relief valve to terminate in to a drain or point of safety
- Connect the 13amp electrical supply to appliance.
- Turn on cold mains water supply to fill appliance.
- Commission appliance in accordance with the installation manual.

IN ORDER TO FIT AN ARISTON ANDRIS LUX ECO IT IS GOOD PRACTICE AND SOMETIMES MANDATORY TO INSTALL ONE OR SEVERAL OF THE FOLLOWING KITS:



### KIT A Expansion Vessel & Non-return Valve

An expansion vessel is a device that takes up the expansion of water in the domestic hot water system when it is heated. This prevents build up of excess pressure. The non-return valve prevents backflow of expanded hot water in to the cold water main.

CODE ARKITA



### KIT B 3.5 Bar Pressure Reducing Valve

The maximum cold water inlet pressure designed for the Andris unit is 3.5 bar therefore this pressure reducing valve controls the water to not exceed this limit.

CODE ARKITB



### KIT C Discharge Tundish

In the event that the hot water system over pressurises, the highly pressurised water is discharged via the 6 bar pressure relief valve and the tundish serves to visually indicate that this discharge is occurring.

CODE ARKITC

# ARISTON

## Pro1-R - Wall Hung Electric Water Heater

- Quality steel tank, 12 bar pressure tested and exclusive vitreous enamel coating
- Environmentally sound and highly efficient thermal insulation
- Magnesium anode to protect against corrosion
- Internal regulation thermostat
- Dual pole thermal cut-out
- Space Saving wall fixing
- Simple Installation
- Max Working temperature 65°C



- 50L Over Sink CODE AR50PROV/3
- 80L Over Sink CODE AR80PROV/3
- 100L Over Sink CODE AR100PROV/3

### DIMENSIONS & WATER TEMPERATURE RECOVER TIMES

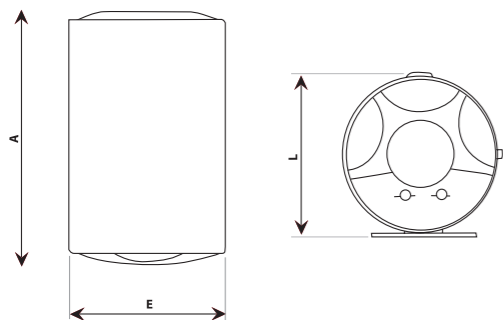

	A	E	L
50 LTR	573mm	450mm	480mm
80 LTR	778mm	450mm	480mm
100 LTR	918mm	450mm	480mm

### Water Temperature Recovery Times

Size	Element	Time
50LTR	1.2KW	160mins
80LTR	1.2KW	260mins
100LTR	1.5KW	280mins

### ENERGY EFFICIENCY



## VELIS EVO - Wall Hung Electric Water Heater



### VELIS EVO Wi-Fi

- Max Working Temperature: 80°C
- Max Working Pressure: 8 Bar
- Power: 1.5KW
- Smart Wi-Fi connection
- Double tank structure and smart Quick Heating function - Shower ready in 50 minutes
- Smart touchscreen Blue Tech display shows the number of showers available and waiting time for next shower
- Daily programming
- Titanium enamelled double tank for increased durability
- Slimline design, and can be installed either vertically or horizontally
- Premium silver metal finish

- 45 LTR CODE AR3626307
- 80 LTR CODE AR3626308

### VELIS EVO

- Max Working Temperature: 80°C
- Max Working Pressure: 8 Bar
- Power: 1.5KW
- Double tank structure and smart Quick Heating function - Shower ready in 50 minutes
- Smart display for easy temperature management with first shower availability alert
- Titanium enamelled double tank for increased durability
- Slimline design, and can be installed either vertically or horizontally
- Premium white finish

- 45 LTR CODE AR3626305
- 80 LTR CODE AR3626306

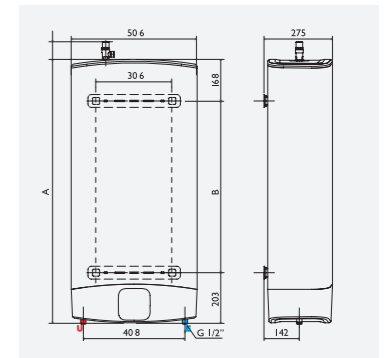

	A	B
VELIS 45	776mm	405mm
VELIS 80	1251mm	695mm

### ENERGY EFFICIENCY



# NOTES

Horizontal lines for writing notes.

## DISTRIBUTION CENTRES

---

### **DUBLIN**

Unit 2  
Bluebell Industrial Estate  
Dublin 12  
T 01 450 4307  
F 01 450 4345  
E [sales@rtlarge.ie](mailto:sales@rtlarge.ie)

### **DUNGANNON**

5 Agharan Road  
Newmills, Dungannon  
Co. Tyrone BT71 4HF  
T 028 8778 4788  
F 028 8778 9988  
E [sales@rtlarge.com](mailto:sales@rtlarge.com)

---

[WWW.RTLARGE.IE](http://WWW.RTLARGE.IE)